



MAKE SURE IT'S RAK

TABLE OF CONTENTS

En This catalogue is the working instrument of all RAK Porcelain distribution channels. The availability of certain products may vary depending on countries. Please check the availability of the products you would like to purchase with the distributor/importer of RAK Porcelain in your area. Current prices apply.

Es Este catálogo es la herramienta de trabajo de todos los circuitos de distribución de RAK Porcelain. La disponibilidad de determinados productos puede variar en función de los países. Les rogamos que comprueben, con el distribuidor/importador de RAK Porcelain de su región, la disponibilidad de los productos que deseen adquirir. Los precios actuales sirven de referencia.

Fr Ce catalogue est l'outil de travail de tous les circuits de distribution RAK Porcelaine. La disponibilité de certains produits pourrait varier selon les pays. Veuillez vérifier auprès du distributeur/importateur de RAK Porcelaine de votre région, la disponibilité des produits que vous aimeriez acquérir. Les tarifs actuels font référence.

It Il presente catalogo rappresenta lo strumento di lavoro di tutti i circuiti di distribuzione di RAK Porcelain Europe. La disponibilità di alcuni prodotti può variare in base al paese. Vi preghiamo pertanto di verificare la disponibilità dei prodotti che desiderate acquistare presso il distributore o l'importatore RAK Porcelain Europe e di fare riferimento alle tariffe attuali.

De Dieser Katalog ist die Arbeitsgrundlage für sämtliche Vertriebstätigkeiten von RAK Porzellan. Die Verfügbarkeit einiger Produkte kann je nach Land variieren. Bitte prüfen Sie bei dem für Ihre Region zuständigen Vertriebspartner bzw. Importeur von RAK Porzellan, ob die von Ihnen gewünschten Produkte verfügbar sind. Maßgeblich ist die aktuelle Preisliste.

 Items or collections showing this symbol are custom made, so please allow additional time for delivery.

Les articles ou collections marqués de ce symbole sont produits à la demande, prévoir un délai d'approvisionnement supplémentaire.

Die Artikel oder Kollektionen mit diesem Symbol werden entsprechend der Nachfrage hergestellt, eine zusätzliche Lieferzeit einplanen.

Los artículos o colecciones que muestra este símbolo se fabrican en función de la demanda. Debe fijarse un período de abastecimiento adicional.

Articoli o collezioni mostrando questo simbolo sono prodotti su richiesta, si prega di quindi di prevedere un termine di consegna supplementare.

4	RAK PORCELAIN		122	LINE-Z
6	MAKE SURE IT'S RAK		126	LYRA
8	5 YEARS ANTI-CHIP GUARANTEE		132	MASSILIA
10	QUALITY		136	MAZZA
12	PRODUCT CARE		140	METROPOLIS
14	SEGMENTATION		144	MINIMAX
18	DESIGNERS		158	NABUR
24	MAREA	NEW	162	NANO
28	GIRO	NEW	168	NORDIC
34	BARISTA	NEW	174	PIXEL
38	PEPPERY	NEW	180	PLAYA
48	SERVICE PLATES	NEW	184	PURE
54	CUSTOM DESIGN	NEW	188	RONDO
58	ALLSPICE		194	SAMBA
66	ANNA		198	SKA
72	B.CONCEPT		204	SKOLA
76	BAHAMAS 2		208	TRIO
80	BANQUET		212	WHITE GOLD
90	BUFFET		218	SMALL & SMART
98	CLASSIC GOURMET		230	HOSPITAL & HEALTHCARE
104	FINE DINE		234	CUPS & SAUCERS
110	GOLDEN		250	SHAPES
116	LEON		252	COOKING DISHES
			258	PLATES SPECIFICATIONS

RAK PORCELAIN, A TALE OF A THOUSAND AND ONE WONDERS



En RAK Porcelain acts as a partner to leaders in all hospitality categories in search of excellence with those that are convinced that the tableware adds value to their table and to their guest experience.

If one of our collections sets off a culinary work perfectly, or if the design of a table service inspires the preparation of the dish, our mission has been successful. The table then becomes an art ...to taste... practical in use and highly aesthetic, this perfectly exemplifies RAK Porcelain's passion at work.

Fr RAK Porcelaine est le partenaire des leaders de la gastronomie, constamment en quête de l'excellence dans leur catégorie. Comme eux, nous sommes conscients de la valeur ajoutée des arts de la table auprès de la clientèle.

Lorsque l'une de nos collections encadre une œuvre culinaire à merveille, ou lorsque le design d'un service de table inspire la préparation des mets, notre mission est accomplie. La table devient alors véritablement un art... qui se déguste. Proposer aux chefs une porcelaine à la fois pratique d'utilisation et esthétique, voilà très exactement le résultat de notre passion.

De RAK Porzellan ist Partner der führenden gastronomischen Trendsetter, die wie wir, von der Wertschöpfung der Tischkultur für die Gastronomie überzeugt sind. „Das Auge isst mit“! Wenn eine unserer Kollektionen ein kulinarisches Meisterwerk einrahmt oder unser Design die Präsentation der Gerichte inspiriert, haben wir unsere Mission erfüllt. Die gastronomische Tafel wird dann tatsächlich zur „essbaren Kunst“.

RAK Porzellan bietet den kreativen Küchenchefs die Möglichkeit zu außergewöhnlichen Präsentationen. Funktionalität, geprägt durch eine erprobte Ästhetik, die sich nach Kundenwunsch anpassen lässt, ist Kerninhalt unserer Leidenschaft.

Es RAK Porcelain actúa como un socio indiscutible de los líderes de la hostelería en todas sus categorías a través de la búsqueda constante de la excelencia. Estamos humildemente convencidos de que nuestras vajillas pueden aportar un valor añadido a la gastronomía y a la experiencia culinaria de ustedes y de sus clientes.

Antes incluso que por el paladar, el entusiasmo entra por los ojos. Cuando una de nuestras colecciones enmarca una obra culinaria de maravilla, o cuando el diseño de un servicio de mesa inspira la preparación de los platos, podemos considerar alcanzada nuestra meta. No es sino entonces cuando la mesa adquiere verdaderamente el estatus de arte, lo que expresa y representa perfectamente la pasión de RAK Porcelain por el trabajo bien hecho.

It RAK Porcelain è il partner di varie aziende leader nel campo della gastronomia costantemente alla ricerca dell'eccellenza nella propria categoria. Come loro, anche noi siamo coscienti del valore aggiunto dell'arte della tavola presso la clientela.

Quando una delle nostre collezioni incornicia alla perfezione un'opera culinaria o quando il design di un servizio da tavola ispira la preparazione dei cibi sappiamo di avere compiuto la nostra missione. La tavola diventa così vera e propria arte... tutta da gustare. La nostra passione: Proporre agli chef una porcellana che offra al contempo praticità di utilizzo e grande valore estetico.

MAKE SURE IT'S RAK

En
Cutting-edge technology

Using cutting-edge technology our collections are designed to withstand intensive use as well as mechanical and thermal shocks inherent in the profession. By selecting raw materials of the highest quality, our products stand up over time to heat of traditional or microwave ovens, while retaining the brilliance of their enamel and the fineness of their decorations.

An optimised worldwide distribution

Linked to a solid worldwide distribution structure, we rely on a network of experts and operators specialising in tableware to serve you wherever and whenever you desire. We insist on providing you with very short lead times.

Fr
Une technologie de pointe

Nos collections sont élaborées grâce à une technologie de pointe pour résister aux usages intensifs ainsi qu'aux chocs thermiques et mécaniques inhérents à la profession. En sélectionnant des matières premières de la plus grande qualité, nos produits résistent sur la durée à la chaleur des fours traditionnels ou micro-ondes, tout en conservant l'éclat de leur émail et la finesse de leurs décorations.

Une distribution mondiale optimisée

Liée à une solide structure de distribution au niveau mondial, nous nous appuyons sur un réseau d'experts et d'opérateurs spécialisés dans les arts de la table afin de vous servir où et quand vous le désirez. Nous tenons à vous assurer des délais d'approvisionnement très courts.

De
Spitzentechnologie

Unsere Kollektionen sind aufgrund einer hochentwickelten Technologie äußerst widerstandsfähig gegenüber intensiver thermischer und mechanischer Beanspruchung. Durch die Auswahl qualitativ hochwertiger Rohstoffe sind unsere Produkte dauerhaft hitzebeständig (gleichermaßen ofen- wie mikrowellengeeignet) – ohne Beschädigungen der Glasur bzw. Einbußen beim Dekor.

Optimierter weltweiter Vertrieb

Unser weltweites Vertriebsnetzwerk besteht aus Experten und Spezialisten der Tischkultur, die Ihnen gern mit Rat und Tat zur Seite stehen. Bei uns können Sie sich auf sehr kurze Lieferzeiten verlassen.

Es
Una tecnología puntera

Nuestras colecciones están elaboradas con tecnología puntera para lograr que resistan a los usos intensivos y a los choques térmicos y mecánicos inherentes a la profesión. Gracias a unas materias primas de la máxima calidad, nuestros productos soportan a largo plazo el calor de los hornos tradicionales o de los microondas, sin perder el brillo de su esmalte y la delicadeza de sus decoraciones.

Distribución mundial optimizada

La distribución, basada en una sólida estructura a escala mundial, cuenta con el apoyo de una red de expertos y operadores especializados en las artes de la mesa que nos permite prestarle servicio en todas partes y en cualquier momento. Nuestro empeño es asegurar unos plazos de suministro muy ajustados.

It
Una tecnologia all'avanguardia

Le nostre collezioni vengono sviluppate grazie a una tecnologia innovativa che assicura la resistenza all'utilizzo intensivo, nonché agli sbalzi termici e meccanici legati all'esercizio della professione. Realizzati con materie prime accuratamente selezionate per offrire la massima qualità, i nostri prodotti resistono al calore dei forni tradizionali e a microonde, conservando intatta la lucentezza dello smalto e la finezza delle decorazioni.

Una distribuzione mondiale ottimizzata

Essendo legati a una solida struttura di distribuzione a livello mondiale, possiamo contare su una vasta rete di esperti e operatori specializzati per servirvi ovunque e in qualsiasi momento. Desideriamo garantirvi dei tempi di approvvigionamento estremamente ridotti.



5 YEARS
ANTI-CHIP
GUARANTEE

En

Product advantage

What makes the difference at RAK Porcelain?

Innovative tabletop collections ... dedicated to professionals, delivered with an unforgettable quality of service... that offer both unmatched artistic and practical levels of quality within the hospitality industry.

What creates excellence at RAK Porcelain?

Creation, inspiration, and especially the constant search for a better balance in the design of products for continuous and intensive use drives RAK Porcelain in its continual pursuit of excellence. Our mission is to improve the daily worries of all our ambassadors in the worldwide foodservice industry. All our collections are shaped for ease in handling, resistance to variations in temperature, and a superior overall strength to insure a long lasting product even within the harsh conditions of the hospitality industry.

We invite you to discover the results of our passion and expertise in the following pages.

Warranty

RAK Porcelain and its distribution networks offer you a limited warranty covering chipping for several collections (contact your dealer for more details). We will replace any of those items that have rim chips, on the condition that the complaint is addressed within 5 years from the date of purchase. This warranty is only valid for the normal use of the products. The warranty does not cover breakage or damage arising from misuse or non-ordinary use of our products.

Fr

Avantage produit

Ce qui fait la différence chez RAK Porcelaine ?

Des collections novatrices dédiées aux professionnels, une proximité et une qualité de service qui nous tiennent à cœur.

Ce qui fait l'excellence ?

La création, l'inspiration, et surtout la recherche constante du meilleur équilibre dans la conception des produits sont étudiées pour une utilisation constante et intensive. Nous avons pour vocation de faciliter le quotidien des professionnels de l'hôtellerie et de la restauration. Aussi nos collections sont toutes façonnées pour une meilleure préhension, une résistance aux variations thermiques et une robustesse supérieure.

Nous vous invitons à découvrir le résultat de notre savoir-faire dans les pages qui suivent.

Garantie

RAK Porcelaine et ses réseaux de distribution vous offrent une garantie limitée couvrant les ébréchures sur plusieurs collections (prière de contacter votre revendeur pour de plus amples informations). Nous remplacerons tout article présentant des ébréchures sur le rebord, à condition que la réclamation nous soit adressée dans les 5 ans à compter de la date d'achat. Cette garantie est uniquement valable en cas d'utilisation normale des produits. La garantie ne couvre pas le bris ou les dommages résultant d'une utilisation abusive ou non-ordinaire de nos produits.

De

Vorteile

Was unterscheidet RAK Porzellan? Es sind die innovativen Kollektionen, die sich hervorragend miteinander kombinieren lassen und die ausgearbeiteten Konzepte für die Gastronomie, sowie die Garantie unserer Dienstleistung und deren Qualität, auf die wir großen Wert legen.

Worauf gründet unser Erfolg?

Die Kreation, die Inspiration, aber insbesondere die konstante Suche nach dem idealen Gleichgewicht zwischen Design und Funktion. RAK Porzellan greift zusätzlich auf eine außergewöhnliche Kompetenz in der Keramikfertigung zurück.

Wir laden Sie ein, auf den folgenden Seiten die Ergebnisse unseres Können zu entdecken.

Garantie

RAK Porzellan und seine Vertriebsstrukturen bieten Ihnen für mehrere Kollektionen eine eingeschränkte Garantie für Kantenabsplitterung (kontaktieren Sie Ihren Händler für weitere Details). Einzelne Artikel mit Kantenabsplitterung werden ersetzt, wenn die Beschwerde innerhalb von 5 Jahren ab dem Kaufdatum eingereicht wird. Diese Garantie gilt nur für den normalen Gebrauch der Produkte. Die Garantie erstreckt sich nicht auf Brüche oder Schäden, die durch Missbrauch oder nicht alltäglichen Gebrauch unserer Produkte entstehen.

Es

Ventajas de los productos

¿Que marca la diferencia en RAK Porcelain?

Innovación en nuestras vajillas, dedicación por y para los profesionales de la hostelería, caracterizada por una inigualable calidad.... Que ofrece al unísono arte y altos niveles de calidad para la industria hostelera. Una disposición original y elegante en sus mesas estimula el paladar gracias a una puesta en escena espectacular, se trata de un valor añadido incomparable que da vida a las creaciones culinarias.

¿Cómo conseguimos la excelencia en RAK Porcelain?

Nuestra misión es facilitarles la vida a los profesionales de la hostelería y la restauración. En consecuencia, la ergonomía de sujeción, la facilidad de uso, la resistencia a las variaciones y contrastes térmicos o mecánicos y una robustez óptima son los valores que presiden el proceso de diseño y de producción de todas nuestras colecciones.

Les invitamos a descubrir el resultado de nuestra pasión y de nuestra experiencia en las siguientes páginas.

Garantía

RAK Porcelain y sus redes de distribución ofrecen una garantía limitada para varias colecciones cubriendo desportilladuras (contacte a su distribuidor para más detalles). Sustituimos cualquier artículo que tiene desportilladuras, con la condición de que la denuncia se hace a menos de 5 años a partir de la fecha de compra. Esta garantía sólo es válida para el uso normal de los productos. La garantía no cubre rotura o daño causado por el mal uso o uso no habitual de nuestros productos.

It

Vantaggi

Che cosa contraddistingue RAK Porcelain da tutti gli altri?

Le collezioni innovative dedicate ai professionisti e l'impegno che dedichiamo all'offerta di un servizio di qualità.

Quali elementi compongono l'eccellenza?

La creazione, l'ispirazione e, soprattutto, l'instancabile ricerca del migliore equilibrio nella concezione di prodotti studiati per un utilizzo continuo e intensivo. La nostra vocazione è quella di facilitare le attività quotidiane dei professionisti del settore alberghiero e della ristorazione. Tutte le nostre collezioni sono state concepite per garantire una maneggevolezza, una robustezza e una resistenza alle variazioni termiche superiori alla media.

Vi invitiamo quindi a scoprire il risultato del nostro know-how nelle pagine seguenti.

Garanzia

RAK Porcelain e le sue reti di distribuzione offrono una garanzia limitata che copre le scheggiature per la maggior parte delle collezioni (per ottenere maggiori informazioni in merito, siete pregati di contattare il vostro rivenditore). Sostituiamo tutti gli articoli che presentano dei bordi scheggiati, a condizione che il reclamo ci venga inviato entro cinque anni a partire dalla data dell'acquisto. Questa garanzia viene considerata valida solo in caso di utilizzo normale dei prodotti. La garanzia non copre le rotture o i danni risultanti dall'abuso o da un uso non regolare dei nostri prodotti.



En

Oven + 300 °C
The RAK oven safe porcelain gradually increases in temperature to ensure gentle cooking of food meaning your dishes will keep their flavour longer.

Fr

Four + 300 °C
La porcelaine RAK mise au four monte progressivement en température pour une cuisson des aliments en douceur. Ainsi, vos préparations conservent leurs saveurs plus longtemps.

De

Ofen + 300 °C
RAK Porzellan erwärmt sich im Ofen progressiv, sodass Lebensmittel schonend gegart werden. Ihre Speisen bewahren ihren Geschmack auf diese Weise länger.

Es

Horno + 300 °C
La porcelana RAK le asegura una cocción o un recalentamiento rápido, sin alterar los sabores ni aromas de sus preparaciones.

It

Forno +300°C
Quando viene messa in forno, la porcellana RAK subisce un aumento della temperatura progressivo, che consente di cuocere gradualmente gli alimenti. In questo modo, le pietanze conservano il loro sapore più a lungo.



Microwave

RAK porcelain ensures cooking or quick reheating without altering the taste or flavour of your dishes.

Micro-ondes

La porcelaine RAK vous assure une cuisson ou un réchauffage rapide sans altération des goûts ou des saveurs de vos préparations.

Mikrowelle

RAK Porzellan garantiert Ihnen ein Garen oder schnelles Aufwärmen ohne Geschmacks- und Aromaveränderung Ihrer Speisen.

Microondas

La porcelana RAK le garantiza una cocción o un calentamiento rápidos sin alterar el gusto o los sabores de sus platos.

Microonde

La porcellana RAK offre una cottura o un riscaldamento rapidi, senza alterare il gusto o il sapore dei piatti.



Holding of temperature

Once put on the table the dishes keep their heat ensuring the content remains at the right temperature giving you the time to enjoy it.

Maintien en température

Une fois sur la table, les plats restent chauds pour maintenir leur contenu à bonne température, le temps de la dégustation.

Warmhalten

Nach dem Servieren bleiben die Teller warm und halten den Inhalt auf einer angemessenen Temperatur, um Speisen ohne Zeitdruck zu genießen.

Mantenimiento de la temperatura

Una vez en la mesa, los platos conservan el calor, para mantener el contenido de estos a la temperatura adecuada durante el tiempo de la degustación.

Mantenimento della temperatura

Una volta a tavola, i piatti restano caldi per mantenere il contenuto alla giusta temperatura durante il periodo di tempo necessario alla degustazione.



Dishwasher

The RAK porcelain's smooth enamel is quick and easy to clean. Thanks to the quality, your tableware will stay as new for a long time.

Lave-vaisselle

L'émail lisse de la porcelaine RAK permet un nettoyage facile et rapide. Grâce à leur grande qualité, vos pièces conserveront longtemps leur aspect neuf.

Geschirrspüler

Die glatte Oberfläche von RAK Porzellan ermöglicht eine schnelle, einfache Reinigung. Dank ihrer hohen Qualität sehen die Produkte auch nach längerem Gebrauch noch wie neu aus.

Lavavajillas

El esmalte liso de la porcelana RAK permite una limpieza fácil y rápida. Gracias a su gran calidad, las piezas estarán como nuevas durante más tiempo.

Lavastoviglie

Lo smalto liscio della porcellana RAK permette un lavaggio facile e veloce. Grazie all'elevata qualità, i vostri prodotti conserveranno il loro aspetto originario molto a lungo.



Mechanical shock

The exceptional hardness of the RAK porcelain ensures it is highly chip and shock resistant. It is therefore very easy to stack.

Choc mécanique

La dureté exceptionnelle de la porcelaine RAK lui confère une grande résistance à l'ébréchure et au choc mécanique. L'empilement des différentes pièces est ainsi facilité.

Mechanische Stöße

Die außergewöhnliche Härte von RAK Porzellan verstärkt die Kantfestigkeit und Widerstandskraft gegenüber mechanischen Stößen. Auf diese Weise wird das Stapeln von Teilen erleichtert.

Choque mecánico

Del congelador al microondas, la porcelana RAK resiste las diferencias de temperatura gracias a la excepcional dureza de su material que le confiere una gran resistencia a los choques térmicos.

Shock meccanico

L'eccezionale durata della porcellana RAK garantisce una grande resistenza alla scheggiatura e agli urti meccanici. L'impilamento dei vari pezzi risulta quindi facilitato.



Thermal shock

From the freezer to the microwave, RAK porcelain withstands differences in temperature thanks to the exceptional hardness of its material making it highly thermal shock resistant.

Choc thermique

Du congélateur au micro-ondes, la porcelaine RAK résiste aux écarts de température grâce à la dureté exceptionnelle de son matériau qui lui confère une grande résistance au choc thermique.

Wärmeshocks

RAK Porzellan widersteht Temperaturunterschieden zwischen Tiefkühlfach und Mikrowelle dank der außergewöhnlichen Härte seines Werkstoffs, die ihm eine hohe Festigkeit gegenüber Temperaturschocks verleiht.

Choque térmico

La porcelana culinaria RAK es un producto 100 % natural, garantizado sin plomo. Al no ser porosa, no absorbe grasas, ni olores, ni bacterias y le garantiza una higiene perfecta.

Shock termico

Dal congelatore al microonde, la porcellana RAK resiste agli sbalzi di temperatura grazie alla durabilità dei suoi materiali, che assicura una grande resistenza alla scheggiatura e agli shock termici.



100% Hygiene

RAK cooking porcelain is a 100% natural, guaranteed lead-free product. It is non-porous and does not absorb grease, odours or bacteria ensuring you optimum hygiene.

100 % Hygiène

La porcelaine culinaire RAK est un produit 100 % naturel, garantie sans plomb. Non poreuse, elle n'absorbe ni graisses, ni odeurs, ni bactéries et vous assure une hygiène parfaite.

100% Hygiene

RAK Küchenporzellan ist ein 100% natürliches Produkt, garantiert bleifrei. Es ist unporös und nimmt daher weder Fett noch Gerüche oder Bakterien auf; es sorgt somit für perfekte Hygiene.

100 % Higiene

La porcelana para vajilla RAK es un producto 100% natural, garantizada sin plomo. Al no ser porosa, no absorbe la grasa, ni los olores, ni las bacterias y le garantiza una higiene perfecta.

Igiene impeccabile

La porcellana RAK è un prodotto naturale al 100% e completamente privo di piombo. Non essendo porosa, non assorbe né grassi, né odori, né batteri e assicura un'igiene perfetta.

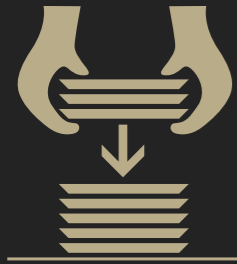

En Stacking

- To preserve the glaze of the flat asymmetrical items, always stack vertically and do not slide one piece onto another.

In the dishwasher

- Follow recommendations of your cleaning product supplier regarding the amount of detergent to use and the use of cleaning products.
- Make sure the dishwashing machine is well-serviced as 80% of the problems are due to low quality maintenance of the dishwashing machine.
- Always rinse the porcelain after use and before you load it into the dishwasher.
- Make sure to wash in separate cycles glass, chinaware, cutlery and cooking equipment (pots and pans).
- If metalmarks appear, clean the surface with Porcelain Cleanser. Check the quality of your cutlery and also wash on a regular basis all working surfaces in stainless steel with a water & vinegar mix. This process will eliminate all metal particles that might be at risk to be transferred on the porcelain.

Chipping

- Chipping is usually the result of rough handling during the washing process or storage.
- Clean the any food remaining on the dinnerware by using a specific utensil; do not hit the dirty plate against the garbage bin.
- RAK hotel grade porcelain is microwave, dishwasher and salamander safe, with most key items being guaranteed against chipping when used under normal conditions.

Fr Empilement

- Pour préserver l'émail protégeant le produit de forme asymétrique, toujours poser verticalement et non pas faire glisser.

Lave-vaisselle

- Suivre les recommandations de votre fournisseur de produits détergents en ce qui concerne le dosage et leur utilisation.
- Assurer la maintenance professionnelle du lave-vaisselle.
- Toujours rincer au préalable les assiettes après utilisation et avant de charger le lave-vaisselle.
- Toujours utiliser des cycles différents pour laver verres, porcelaine, couverts ou équipements de cuisine (casserolles et poêles).
- Si des traces métalliques apparaissent, nettoyer l'article en porcelaine avec du détergent liquide, revoir éventuellement la qualité des couverts, et nettoyer régulièrement les surfaces de travail inoxydables p.ex. à l'eau vinaigrée. Ce processus servira à éliminer les particules métalliques qui risquent de se déposer sur la porcelaine.

Ebréchure

- Les ébréchures sont souvent le résultat de manipulations inadéquates durant le processus de lavage ou de rangement.
- Ne pas taper l'assiette contre le bord de la poubelle, il est recommandé d'utiliser un outil ou l'eau pour dégager le surplus de nourriture.
- La porcelaine professionnelle de RAK passe au four micro-ondes, sauf si elle est décorée de métaux précieux (or/platine).

De Stapeln

- Um die Glasur des Produkts zu schützen, ist es angebracht, flache asymmetrische Geschirrtteile aufeinander zu stapeln und nicht horizontal ineinander gleiten zu lassen.

Geschirrspülmaschine

- Befolgen Sie die Empfehlungen Ihres Herstellers für Spülmittel, speziell in puncto Dosierung.
- Die Geschirrspülmaschine ist regelmäßig zu warten, 80% der aufgetretenen Probleme sind auf eine unzureichende Wartung der Maschinenteile zurückzuführen.
- Grobe Essensreste müssen mit kaltem Wasser von den Tellern entfernt werden, bevor die Spülmaschine bestückt wird.
- Beachten Sie, dass stets getrennte Spülgänge für Gläser, Porzellan, Besteck und Küchengeräte (Töpfe und Pfannen) gewählt werden.
- Wenn dunkle Spuren auf der Glasur auftreten, reinigen Sie den Artikel mit einem weichen Tuch und flüssigem Scheuermittel (Porzellanreiniger). Prüfen Sie ggf. die Qualität Ihrer Bestecke. Reinigen Sie regelmäßig mit einer Wasser-Essig Lösung alle Arbeitsflächen aus Edelstahl in Ihrer Küche. Dieser Vorgang eliminiert Metallpartikel die sich am Porzellan absetzen können.

Kantenabsplitterung

- Kantenabsplitterungen sind zumeist das Ergebnis eines nicht-fachgerechten Umgangs während des Spülvorgangs oder beim Einräumen/Transport des Geschirrs.
- Schlagen Sie den Teller nicht gegen den Rand des Müllimers, benutzen Sie eine Gabel oder eine Dusche um die Reste vom Teller zu spülen.
- Unser Porzellan ist, dank einer verstärkten Scherbenhärte, für den Mikrowellenherd, den Geschirrspüler und den Salamander geeignet. Wichtige Porzellanteile die bei normaler Nutzung eine Kantenabsplitterung aufweisen, werden ersetzt.

Es Apilamiento

- Para preservar el esmalte vidriado de los productos asimétricos, apilar siempre verticalmente y no deslizar en horizontal.

Lavavajillas

- Seguir las recomendaciones de uso de su proveedor de productos detergentes en lo relativo a su dosificación y manejo.
- Realizar siempre el debido mantenimiento del lavavajillas, ya que el 80% de los problemas surgidos provienen de un mantenimiento incorrecto.
- Enjuagar siempre los platos después de su uso y antes de introducirlos en el lavavajillas.
- Utilizar siempre ciclos diferentes para lavar vidrio, porcelana, cubiertos o baterías de cocina.
- Si aparecen huellas metálicas, limpiar el artículo de porcelana con jabón líquido sanitario.
- Si aparecen marcas de metal en su porcelana primero limpie la superficie con un limpiador de porcelanas. Compruebe la calidad de sus cubiertos y lave a menudo las superficies trabajo, especialmente aquellas donde se usen éstos, con una mezcla de agua y vinagre. Este proceso eliminará todas las partículas de metal que pudieran ser transferidas a las piezas de porcelana. Las marcas de metal también pueden deberse al apilamiento, cuando hay bajo un plato polvo metálico de acero inoxidable y éste se deposita sobre la parte superior de la siguiente pieza de vajilla.

Desportilladuras

- El desportillado es a menudo el resultado de una manipulación muy brusca durante el proceso de lavado o colocación.
- No sacudir el plato contra el borde del cubo de la basura, utilizar mejor un tenedor, o un utensilio de cocina específico para tirar las sobras.
- Nuestra porcelana profesional es compatible con el microondas y el lavavajillas, y presenta una gran resistencia a las desportilladuras, siempre teniendo en cuenta que se den las en condiciones normales y adecuadas de uso.

It Impilamento

- Per preservare lo smalto che protegge i prodotti dalla forma asimmetrica, posateli sempre verticalmente ed evitate che scivolino.

Lavastoviglie

- Seguite le raccomandazioni del vostro fornitore di detergenti per quanto concerne il dosaggio e l'impiego di questi ultimi.
- Assicurate una manutenzione professionale della lavastoviglie.
- Risciacquate sempre i piatti dopo l'utilizzo e prima di caricare la lavastoviglie.
- Utilizzate cicli diversi per lavare vetro, porcellana, posate e altri utensili da cucina (pentole e padelle).
- In presenza di tracce metalliche, lavate porcellana con un detergente liquido, esaminate eventualmente la qualità delle posate e pulite regolarmente le superfici di lavoro inossidabili ad es. con acqua e aceto. Questa procedura serve a eliminare le particelle metalliche che possono depositarsi sulla porcellana.

Scheggiatura

- Le scheggiature sono spesso il risultato di manipolazioni non adeguate durante i processi di lavaggio o di sistemazione.
- Evitate di sbattere il piatto contro il bordo della pattumiera: per gettare gli avanzi di cibo, è consigliabile aiutarsi con uno strumento o con dell'acqua.
- La porcellana professionale RAK può essere messa nel forno a microonde, salvo nel caso in cui sia decorata con metalli preziosi (oro/platino).

INSPIRATIONAL DINING

En
With our serving ware leading chefs can let their imagination run wild with the INSPIRATIONAL DINING collections, offering a number of different designs and a myriad of possibilities.

Fr
Pour que les grands chefs puissent laisser libre cours à leur imagination, les collections INSPIRATIONAL DINING offrent des designs variés et une myriade de possibilités.

De
Damit die großen Meisterköche ihrer Kreativität freien Lauf lassen können, bieten die Kollektionen INSPIRATIONAL DINING unterschiedliche Designs und eine Vielzahl von Möglichkeiten.

Es
Para que los mejores chefs puedan dar rienda suelta a su imaginación, las colecciones INSPIRATIONAL DINING ofrecen diseños variados y una miríada de posibilidades.

It
Perché i grandi chef possano dare libero sfogo alla loro immaginazione, le collezioni INSPIRATIONAL DINING offrono design vari e una miriade di possibilità.

ELEGANT DINING

En
Complete, timeless, ultra-chic or classic, the ELEGANT DINING collections are the heart and soul of these fine porcelain dinner services, designed specifically for the hotel industry.

Fr
Complètes, intemporelles, ultra-chics ou classiques, les collections ELEGANT DINING forment l'âme même des services de porcelaine raffinés consacrés à l'hôtellerie.

De
Die umfassenden, zeitlosen, hochmodernen oder klassischen Kollektionen ELEGANT DINING bilden die Seele der raffinierten Porzellan-Service für den Hotelbereich.

Es
Completas, atemporales, sumamente elegantes o clásicas, las colecciones ELEGANT DINING constituyen el alma misma de los servicios de porcelana refinados consagrados a la hostelería.

It
Complete, senza tempo, ultra-chic o classiche, le collezioni ELEGANT DINING rappresentano l'anima stessa dei raffinati servizi di porcellana ideati per il settore dell'ospitalità.

CASUAL DINING

En
The CASUAL DINING range is the perfect answer when a balance between functionality, durability and elegance is key.

Fr
Partout où l'équilibre entre fonctionnalité, robustesse et élégance est indispensable, les articles de la gamme CASUAL DINING ont leur place.

De
Überall dort, wo Funktionalität, Robustheit und Eleganz gleichermaßen gefragt sind, kommt die Kollektion CASUAL DINING zum Einsatz.

Es
Donde el equilibrio entre la funcionalidad, la robustez y la elegancia es indispensable, no pueden faltar los artículos de la gama CASUAL DINING.

It
Ovunque, dove l'equilibrio tra funzionalità, robustezza ed eleganza è indispensabile, gli articoli della gamma CASUAL DINING trovano il loro posto.

ALL PURPOSE DINING

En
RAK Porcelain sets strict standards for its products to ensure they stand up to daily professional use. The ALL PURPOSE DINING collections are designed specifically for commercial and mass catering.

Fr
RAK Porcelaine impose à ses produits des critères sévères afin de convenir à l'usage des professionnels au quotidien. Les collections ALL PURPOSE DINING sont dédiées à l'exploitation en restauration commerciale et collective.

De
RAK Porzellan legt strenge Maßstäbe bei seinen Produkten an, damit sie für den täglichen Gebrauch im professionellen Bereich geeignet sind. Die Kollektionen ALL PURPOSE DINING sind für den Einsatz in der Großgastronomie bestimmt.

Es
RAK Porcelain impone a sus productos criterios rigurosos para que sirvan para el uso profesional cotidiano. Las colecciones ALL PURPOSE DINING están dedicadas a la explotación en restauración comercial y colectiva.

It
RAK Porcelain impone ai suoi prodotti criteri severi affinché siano adatti ad essere impiegati ogni giorno dai professionisti. Le collezioni ALL PURPOSE DINING sono dedicate alla ristorazione commerciale e collettiva.

SPECIALTY DINING

En
RAK Porcelain has adapted its designs to reflect the incredible diversity of culinary delights offered by the restaurant world, so the sources of inspiration can be varied, creating a range of different styles and feelings.

Fr
La diversité des offres gastronomiques à travers le monde en restauration est telle que RAK Porcelaine a adapté des décors pour donner la possibilité de varier ses sources d'inspirations et créer diverses atmosphères.

De
Die gastronomischen Angebote in der ganzen Welt sind so vielfältig, dass RAK Porzellan durch eine Anpassung der Dekore die Möglichkeit eröffnen möchte, die Inspirationsquellen zu variieren und unterschiedliche Atmosphären zu schaffen.

Es
La diversidad de las ofertas gastronómicas en el mundo de la restauración es tal que RAK Porcelain ha adaptado las decoraciones para que pueda variar sus fuentes de inspiración y crear atmósferas diversas.

It
La diversità delle offerte gastronomiche nel mondo della ristorazione è tale che RAK Porcelain ha adattato i decori in funzione della possibilità di variare le sue fonti di ispirazione e creare atmosfere diverse.

ADDITIONS

En
The RAK Porcelain range would be incomplete without these essential additional products. The ADDITIONS range, including accessories and, items with specific uses and for specific services, is a treasure trove marrying inventiveness with functionality.

Fr
La gamme RAK Porcelaine serait incomplète sans les indispensables produits complémentaires. Entre accessoires, articles aux fonctions spécifiques et de service, ADDITIONS recèle des trésors d'inventivité et de fonctionnalité.

De
Das RAK Porzellan Sortiment wäre ohne die unentbehrlichen ergänzenden Produkte unvollständig. Neben Zubehör, Artikeln mit spezifischer Funktion und für den Service birgt ADDITIONS wahre Schätze an Einfallsreichtum und Funktionalität.

Es
La gama RAK Porcelain estaría incompleta sin los indispensables productos complementarios. Entre accesorios, artículos de función específica y de servicio, ADDITIONS encierra tesoros de la imaginación y la funcionalidad.

It
La gamma RAK Porcelain sarebbe incompleta senza gli indispensabili prodotti complementari. Tra accessori, articoli dalle funzioni specifiche e di servizio, ADDITIONS racchiude tesori di inventività e funzionalità.

INSPIRATIONAL DINING

ELEGANT DINING

CASUAL DINING

ALL PURPOSE DINING

SPECIALTY DINING

ADDITIONS

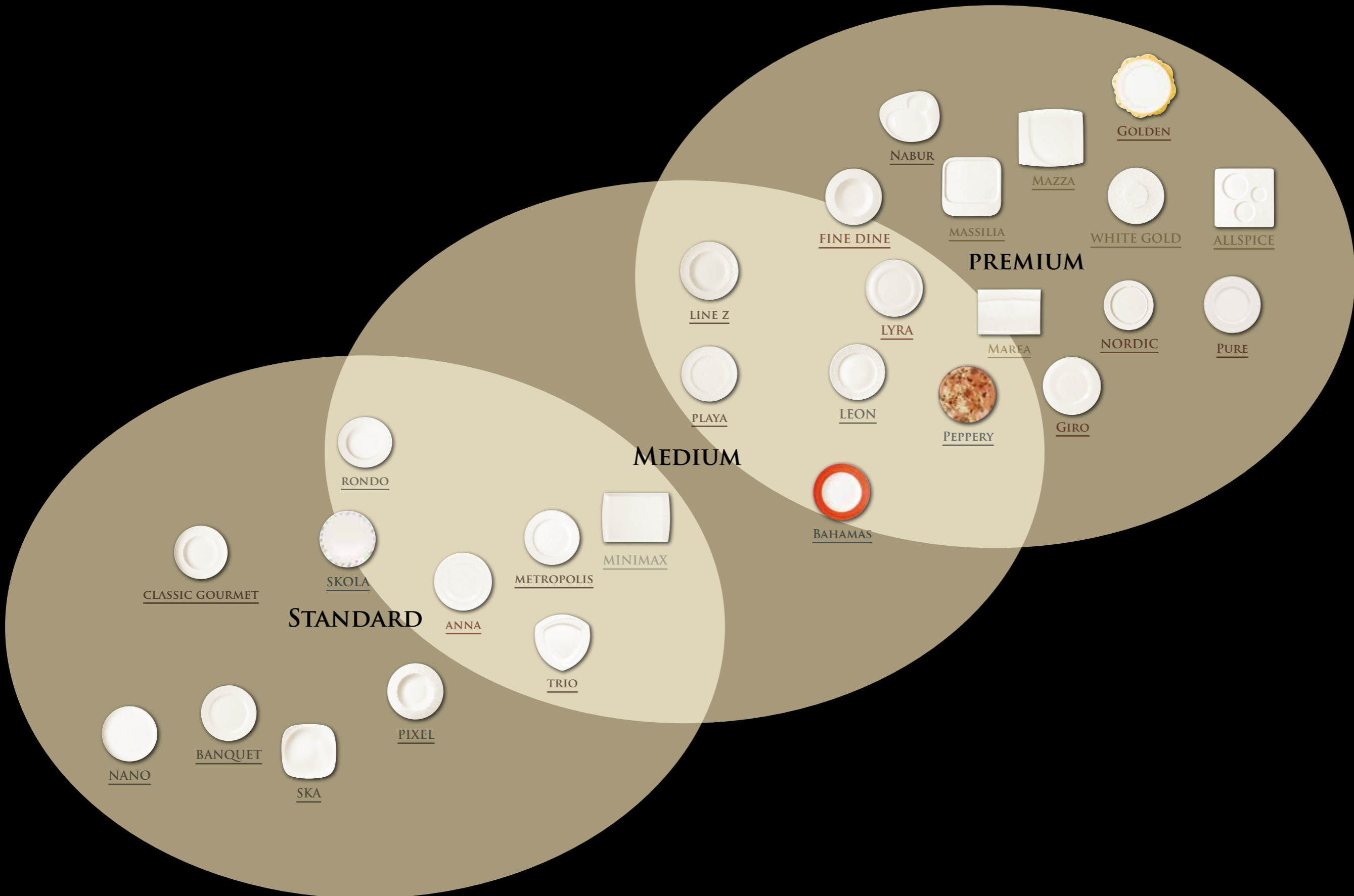



GIRO COLLECTION

En

Gemma Bernal has spent her professional life in design, thinking of products in a different light. In her opinion, a designer is a person who captures different aspects of life: functional, economic, social, marketing, production etc. through its own sensitivity. Ideas and design proposals arise out of this multidisciplinary conception and a close relationship with the right people. She shares her work life between design creation and design teaching that forced her to define, explain and communicate her own vision. Gemma's work has been tremendously influenced by Mediterranean atmosphere and particularly Barcelona in terms of sun, light and joyful people sharing meals together on restaurants' terraces. Gemma has worked with various renowned chefs sharing a Mediterranean vision. In the past years, she has found inspiration in young chefs and professional reviewers seeking different approaches in culinary activities. Gemma designed two beautiful collections called MAREA and GIRO developed by RAK Porcelain. MAREA features different pieces for tapas dishes, main and side dishes to bring up culinary presentations. These pieces have been conceptualized for a specific use and design oriented to ease service and product manipulation. GIRO is based on geometric forms in which identical shapes in different sizes have been somewhat arbitrarily inserted. The result is an appearance of different sized tilted planes and inclinations showcasing the design's dexterity and originality. Gemma feels very comfortable working in close cooperation with other designers in a lab for ideas developing new concepts related to food and cooking.

Fr

Gemma Bernal a consacré sa vie professionnelle au design, envisageant les produits sous un angle différent. Selon elle, un designer est une personne qui saisit différents aspects de la vie – fonctionnels, économiques, sociaux, marketing, de production, etc. – en fonction de sa propre sensibilité. Les idées et les propositions de design naissent de cette conception pluridisciplinaire et d'une relation étroite avec les bonnes personnes. Elle partage sa vie professionnelle entre la création de design et l'enseignement du design qui l'a amené à définir, expliquer et communiquer sa propre vision. Le travail de Gemma a été considérablement influencé par l'atmosphère méditerranéenne, notamment Barcelone, en termes de soleil, de lumière et de personnes prenant gaiement leurs repas ensemble sur les terrasses des restaurants. Gemma a travaillé avec divers chefs de renom partageant sa vision de la Méditerranée. Ces dernières années, elle a trouvé l'inspiration auprès de jeunes chefs et de critiques professionnels recherchant différentes approches en termes d'activités culinaires. Gemma a conçu deux superbes collections baptisées MAREA et GIRO développées par RAK Porcelaine. MAREA comprend différentes pièces pour des plats de type tapas, des plats principaux et des plats d'accompagnement pour mettre en valeur des présentations culinaires. Ces pièces ont été conceptualisées pour une utilisation spécifique et un design destiné à faciliter le service et la manipulation du produit. GIRO repose sur des formes géométriques dans lesquelles des formes identiques dans des tailles différentes ont été insérées de manière arbitraire. Le résultat est une apparence de plans inclinés et d'inclinaisons de tailles différentes illustrant la dextérité et l'originalité du design. Gemma se sent dans son élément lorsqu'elle travaille en étroite collaboration avec d'autres designers dans un laboratoire dans le but de faire naître des idées développant de nouveaux concepts liés à la nourriture et à la cuisine.

De

Gemma Bernal hat ihr berufliches Leben mit Design verbracht und damit, Produkte in einem anderen Licht zu betrachten. Ihrer Meinung nach handelt es sich bei einem Designer um einen Menschen, der die verschiedenen Aspekte des Lebens durch sein eigenes Empfinden erfasst: Funktionalität, Wirtschaftlichkeit und Gesellschaft, Marketing, Herstellung usw. Ideen und Designvorschläge entstehen aus diesem multidisziplinären Konzept und einer engen Beziehung zu den richtigen Menschen. Sie teilt ihr Arbeitsleben zwischen der Designerstellung und der Designlehre auf, sodass sie gezwungen war, ihre eigene Vision zu definieren, zu erklären und zu vermitteln. Gemmas Werk wurde stark von einer mediterranen Atmosphäre - und insbesondere von Barcelona - beeinflusst, was Sonne, Licht und fröhliche Menschen betrifft, die auf der Terrasse eines Restaurants gemeinsam eine Mahlzeit zu sich nehmen. Gemma hat mit verschiedenen bekannten Köchen zusammengearbeitet, die eine mediterrane Vision teilen. In den letzten Jahren ließ sie sich von jungen Köchen und professionellen Kritikern inspirieren und suchte nach neuen Ansätzen für ihre kulinarischen Aktivitäten. Gemma hat zwei wunderschöne Kollektionen entworfen, MAREA und GIRO, die von RAK Porzellan entwickelt wurden. MAREA zeigt verschiedene Stücke zur kulinarischen Präsentation von Tapas-Gerichten, Hauptspeisen und Beilagen. Diese Stücke wurden für den besonderen Gebrauch konzeptioniert, und ihr Design soll die Bedienung bei Tisch sowie die Handhabung des Produktes vereinfachen. GIRO basiert auf geometrischen Formen, in die wiederum die gleiche Geometrie in verschiedenen Größen ein wenig willkürlich eingefügt wurde. Das Ergebnis ist ein Erscheinungsbild schräger Ebenen von unterschiedlicher Größe und Neigung, die die Gewandtheit und die Originalität dieses Designs deutlich werden lassen. Gemma arbeitet sehr gerne eng mit anderen Designern in einem Ideenlabor zusammen und entwickelt neue Konzepte im Bereich Essen und Kochen.

Es

Gemma Bernal ha pasado toda su vida diseñando. Pensando en productos de diversa índole. Piensa en el diseñador como una persona que capta distintos aspectos: Funcionales, económicos, sociales, marketing, producción, actualidad etc. De ésta visión pluridisciplinar y del contacto con las personas adecuadas, surgen las ideas y propuestas. Comparte su vida laboral con la enseñanza del diseño y nos cuenta como ha aprendido enseñando ya que le ha obligado a saber definir y explicar las cosas. La influencia mediterránea, el sol, la luz, la gente en la calle, el ambiente de Barcelona... son cosas que influyen en Gemma enormemente. Estamos en un lugar en que se vive mucho en la calle, se disfruta mucho celebrando cosas en grupo y casi siempre en restaurantes. Gemma ha trabajado con diversos e importantes chefs, también con una visión muy mediterránea. En los últimos años ha buscado fuentes de inspiración en chefs jóvenes, personas críticas que se plantean aspectos de interés relacionados con el acto de comer, y las distintas formas de hacerlo. RAK ha desarrollado los proyectos MAREA y GIRO. MAREA propone distintas piezas con funciones muy concretas. Productos para tapas, para complementos de una presentación culinaria o como un gran plato. Piezas que tienen una utilidad concreta y una resolución clara para el servicio y la manipulación del producto. GIRO se basa en formas geométricas básicas en las que se insertan unas formas iguales, de distintas dimensiones, de una manera un tanto arbitraria. El resultado es la aparición de planos inclinados de distintas dimensiones e inclinaciones que le dan al producto un gran interés formal. Gemma se siente muy cómoda desarrollando, junto con otros diseñadores que trabajan en el laboratorio de ideas, nuevos conceptos relacionados con la gastronomía y la cocina.

It

Gemma Bernal ha trascorso tutta la sua vita professionale nel design, pensando ai prodotti sotto una luce diversa. Secondo lei, un designer, grazie alla sua sensibilità, riesce a catturare differenti aspetti della vita: funzionale, economico, sociale, marketing, produzione e tanti altri. Le idee e le proposte di design prendono vita da questa concezione multidisciplinare e da una stretta relazione con le persone giuste. Gemma condivide la sua vita lavorativa tra creazione di design e insegnamento del design, e ciò la porta a definire, spiegare e comunicare la sua visione. Il lavoro di Gemma è stato straordinariamente influenzato dall'atmosfera mediterranea e, in particolare, da Barcellona in termini di sole, luce e persone gioiose, pranzando insieme a loro nei dehors dei ristoranti. Gemma ha lavorato con vari chef di fama con cui condivide una visione mediterranea. In passato, ha trovato ispirazione nei giovani chef e nei critici professionisti che cercano approcci differenti nelle attività culinarie. Gemma ha disegnato due fantastiche collezioni chiamate MAREA e GIRO sviluppate da RAK Porcelain. MAREA è costituita da pezzi differenti per tapas, piatti principali e contorni che mettono in luce le presentazioni culinarie. Questi pezzi sono stati concettualizzati per un uso specifico e orientati al design per facilitare il servizio e la manipolazione dei prodotti. GIRO si basa su forme geometriche, dove sono state inserite arbitrariamente sagome identiche di misure differenti. Ne risulta un'immagine di inclinazioni e piani pendenti di varie misure che evidenziano l'abilità e l'originalità del design. Gemma si sente a proprio agio a lavorare in stretta collaborazione con altri designer in un laboratorio di idee sviluppando nuovi concetti legati al cibo e alla cucina.



DESIGN ON NORDIC CUPS

En

From hunting weapons to tableware, Françoise Bœur has an extensive track record in graphic design, characterised by creativity, love of detail and above all this, a great passion.

Françoise Bœur was born in 1964 in Bastogne, Belgium. From an early age, craftsmanship and nature were strong influences in her life. When she was 20, she qualified as an art teacher from the Avroy Institute in Liège, Belgium, and started teaching.

In 1986 she moved into an unusual and globally sought-after specialism by becoming a hunting weapon engraver at the Léon-Mignon Institute in Liège. She has done an extensive range of artistic work: poster contests, animal drawings, pencil sketch exhibitions and more. Françoise has always been guided in her work by a leitmotiv: producing unique and realistic artwork, exhibiting a great attention to detail. In 1988 she shifted into the world of tableware, for hotels and restaurants in particular. She is active in creating and fully developing custom designs on porcelain for prestigious clients all around the world. Her portfolio includes the London Hilton Hotel, Relais & Châteaux, Radisson Kuwait, Disneyland Paris, the Colloseo Hotel at Europa Park, Casino Barrière, the Grand-Ducal Palace of Luxembourg, star-rated restaurants such as Léa Linster, and a catalogue of designs that have enjoyed fully-deserved success with her clients. She joined the young team at RAK Porcelain Europe in 2010, and since then she has produced many outstanding designs for a wide variety of establishments in Europe. This allows her to put her talents to use to make remarkable and acclaimed works.

Fr

Des armes de chasse aux arts de la table, Françoise Bœur possède un long parcours de designer graphique marqué par la créativité, l'amour du détail et surtout la passion.

Françoise Bœur naît en 1964 à Bastogne en Belgique. Son enfance est fortement imprégnée par le travail artisanal et la nature. A 20 ans déjà, elle obtient le diplôme de professeur d'arts plastiques de l'institut Avroy de Liège (Belgique) et commence à enseigner. Elle poursuit en 1986 avec une spécialisation rare et mondialement recherchée : elle devient graveur ciseleur sur arme de chasse à l'institut Léon-Mignon de Liège. Ses activités artistiques s'étendent : concours d'affiches, dessins animaliers, expositions de dessins au crayon etc. Un leitmotiv guide Françoise pour ses travaux : composer des œuvres réalistes et atypiques basées sur le souci du détail.

En 1988 elle se tourne vers l'univers des arts de la table précisément dans le secteur de l'hôtellerie restauration. Elle participe à l'étude et à la réalisation intégrale de décors personnalisés sur la porcelaine pour des clients prestigieux dans le monde entier. A son actif : hôtel Hilton London, les Relais & Châteaux, Radisson Koweit, Disneyland Paris l'hôtel, Colloseo à Europa Park, Casino Barrière, le palais grand-ducal de Luxembourg, des restaurants étoilés comme Léa Linster ainsi que des décors en catalogue ayant rencontré un succès auprès de ses clients entièrement mérité. Elle rejoint la toute jeune équipe de RAK Porcelain Europe en 2010 avec laquelle elle développe de nombreux et exceptionnels décors pour des établissements européens très divers. Elle a ainsi l'occasion de mettre son talent à profit pour des créations remarquables et remarquées.

De

Von Jagdwaffen bis zu Tafelgeschirr verzeichnet Françoise Bœur eine umfassende Erfolgsgeschichte im Bereich Grafikdesign, die von Kreativität, Liebe zum Detail und vor allem einer großen Leidenschaft geprägt ist. Françoise Bœur wurde 1964 in Bastogne, Belgien, geboren. Schon in jungen Jahren haben Handwerkskunst und Natur ihr Leben stark beeinflusst. Als sie 20 Jahre alt war, machte sie ihren Abschluss als Kunstlehrerin am Avroy-Institut in Lüttich, Belgien, und begann mit ihrer Lehrtätigkeit.

1986 spezialisierte sie sich auf einem ungewöhnlichen und weltweit gefragten Gebiet, indem sie am Léon-Mignon-Institut in Lüttich zur Graveurin für Jagdwaffen wurde. Sie hat viele Gebiete der Kunst abgedeckt: Plakatwettbewerbe, Tierzeichnungen, Ausstellungen von Bleistiftskizzen u.v.m. Françoise folgte bei ihren Arbeiten immer einem Leitmotiv: einzigartige und realistische Kunstwerke zu schaffen, die eine große Liebe zum Detail zeigen. 1988 wandte sie sich der Welt des Tafelgeschirrs zu, insbesondere für Hotels und Restaurants. Sie ist arbeitet aktiv an der Gestaltung und der vollständigen Entwicklung maßgefertigter Designs auf Porzellan für angesehene Kunden in der ganzen Welt. Ihr Portfolio umfasst das London Hilton Hotel, Relais & Châteaux, Radisson Kuwait, Disneyland Paris, das Colloseo Hotel im Europapark, Casino Barrière, der Grand-Ducal Palace von Luxemburg, Sterne-Restaurants wie das Léa Linster sowie einen Katalog mit Designs, die bei ihren Kunden zu wohlverdientem Erfolg führten.

Im Jahr 2010 schloss sie sich dem jungen Team bei RAK Porcelain Europe an und hat seither viele hervorragende Designs für eine große Zahl europäischer Unternehmen entworfen. Auf diese Weise kann sie ihr Talent dazu nutzen, außergewöhnliche und anerkannte Werke zu schaffen.

Es

Françoise Bœur posee una amplia trayectoria en diseño gráfico, desde armas de caza a vajillas, caracterizada por su creatividad, su pasión por el detalle y, sobre todo, su gran amor por lo que hace. Françoise Bœur nació en 1964 en Bastogne, Bélgica. Desde muy temprana edad, la naturaleza y la artesanía ejercieron una gran influencia en su vida. A la edad de 20 años obtuvo una plaza como profesora de arte en el Instituto Avroy de Lieja, en Bélgica, donde se dedicó a la enseñanza.

En 1986 inició su especialidad en el Instituto Léon-Mignon de Lieja en un área poco cultivada y muy reconocida en todo el mundo, al convertirse en grabadora de armas de caza. Su trabajo artístico, que es amplio y muy variado, abarca concursos de carteles, dibujos de animales, exposiciones de bocetos a lápiz y mucho más. La obra de Françoise está siempre guiada por el leitmotiv de producir un trabajo artístico realista y único, con una gran atención al detalle. En 1988 entró en el mundo del diseño de vajillas y artículos de mesa, en especial para hoteles y restaurantes, donde ha sido particularmente activa en la creación y el desarrollo en todas sus fases del diseño de porcelanas por encargo de clientes prestigiosos de todas partes del mundo. Entre sus clientes figuran el Hotel Hilton de Londres, Relais & Châteaux, Radisson Kuwait, Disneyland Paris, el Hotel Colloseo de Europa Park, Casino Barrière, el Palacio del Gran Ducado de Luxemburgo y restaurantes de primera categoría como el Léa Linster, y posee un amplio catálogo de diseños que goza de una merecida reputación entre sus clientes.

Desde su ingreso en 2010 al joven equipo de RAK Porcelain Europe, ha creado una multitud de sorprendentes diseños para una gran variedad de establecimientos europeos. Todo ello es prueba fehaciente de su talento para crear obras merecedoras de aclamación.

It

Dai fucili per la caccia ai servizi per la tavola, Françoise Bœur ha una profonda esperienza nel graphic design, caratterizzata da creatività, amore per il dettaglio e, soprattutto, una grande passione.

Françoise Bœur è nata nel 1964 a Bastogne, in Belgio. Fin dall'inizio, la maestria artigiana e la natura hanno avuto un peso importante nella sua vita. Quando aveva 20 anni, si è qualificata come insegnante d'arte presso l'Avroy Institute di Liegi, in Belgio, e ha iniziato a insegnare.

Nel 1986 si è specializzata in un settore insolito e globalmente ricercato diventando incisore di fucili da caccia al Léon-Mignon Institute di Liegi. Ha lavorato su un'ampia gamma di opere artistiche: ha creato poster per concorsi, disegni di animali, ha organizzato mostre di schizzi a matita e tanto altro. Il lavoro di Françoise è sempre stato percorso da un leitmotiv: produrre opere d'arte uniche e realistiche, con una straordinaria attenzione al dettaglio.

Nel 1988 è passata al mondo dei servizi per la tavola, in particolare per gli hotel e i ristoranti. È attiva nella creazione e nello sviluppo completo di design personalizzati su porcellana per prestigiosi clienti in tutto il mondo. Il suo portfolio comprende il London Hilton Hotel, Relais & Châteaux, Radisson Kuwait, Disneyland Paris, il Coloseo Hotel all'Europa Park, il Casino Barrière, il Palazzo Granducale di Lussemburgo, ristoranti stellati come Léa Linster, e un catalogo di design che le hanno valso il meritato successo con i suoi clienti. È entrata a far parte dell'equipe di RAK Porcelain Europe nel 2010, e da allora ha prodotto tantissimi design eccezionali per un'ampia varietà di strutture in Europa. Questo le consente di sfruttare il proprio talento per creare lavori straordinari e acclamati.



ANNA COLLECTION

En

For Mikaëla Dörfel, “every design must have its own personality”. Mikaëla Dörfel grew up in Finland, where she developed a fascination for Scandinavian shapes. Her design takes its inspiration from an ancient farm surrounded by horses and meadows dotted with small lakes, directly from nature itself, underpinned by a defined structure. She has also based her design studio there, to the north of Hamburg for over 15 years, and she works for brands sold in Europe, Asia and the United States. “Of course, a collection begins its life as a concept, but from that moment on every single detail counts in creating it. The strength of the concept is its simplicity and accessibility. The concept must inspire, awaken the senses, function independently and do justice to the natural materials”. A concept responds to a utilitarian need, and is born from the marriage of understanding shapes and thinking logically to create a product which is both stylish and functional. Making models is still a very important step in creating the collection, as this is the stage where every detail can be perfected. Mikaëla Dörfel adopts a tactile approach to her work. She likes to touch the porcelain with her own hands to ensure the shapes function well in daily use. “Errors are often easier to detect through touch.” Mikaëla Dörfel’s aim is to do justice to the quality of the material used. Her modern, elegant style seeks to find harmony between the tension of straight lines and curves. Her intuition for shapes is paired with a deep knowledge and understanding of the materials and production methods used, both new and old. Mikaëla Dörfel has an understanding of materials and markets. Her work is characterised by creativity and determination. Her love of shape drives her to create collection pieces which bypass trends in favour of longevity. Some of her collections are more than several decades old. Her work has already been recognised with a number of design awards. Mikaëla Dörfel’s style is an example of timeless elegance and innovation, while still remaining extremely practical.

Fr

Pour Mikaëla Dörfel, « chaque design doit posséder sa personnalité propre ». Mikaëla Dörfel a grandi en Finlande d’où elle garde une fascination des formes scandinaves. Etablie dans une ancienne ferme entourée de chevaux et de prairies parsemées d’étangs, son design s’inspire directement de la nature soutenue par une structure claire. Son studio de création se trouve là, au nord de Hambourg installé depuis plus de 15 ans et travaille pour des marques distribuées en Europe, en Asie et aux Etats-Unis. « Bien sûr, une collection naît à partir d’une idée, mais ensuite chaque détail compte pour la réaliser. La simplicité du concept et son évidence font sa force. Le concept doit inspirer, éveiller des sensations, fonctionner de manière indépendante et rendre justice au matériau employé de façon naturelle ». Un concept répond à un besoin utilitaire et naît de la combinaison d’une sensibilité des formes, alliée à la réflexion logique pour créer un produit aussi design que fonctionnel. La création des maquettes reste une étape très importante dans le façonnage d’une collection puisqu’elle permet de parfaire chaque petit détail. Mikaëla Dörfel cultive une approche tactile. Elle aime sentir la porcelaine sous ses doigts pour vérifier la fonctionnalité des formes dans leur utilisation quotidienne. « Les erreurs sont parfois plus faciles à détecter grâce au toucher. » Mikaëla Dörfel cherche à rendre justice à la qualité du matériau employé. Son style moderne et élégant cherche l’harmonie entre lignes de tension et courbes. Son intuition pour les formes va de pair avec sa connaissance profonde des matériaux et des méthodes de production anciennes ou modernes. Mikaëla Dörfel possède une connaissance des matériaux et des marchés. Sa créativité et son exigence caractérisent son travail. Son amour des formes la conduit à créer des pièces de collection qui évitent les modes et s’inscrivent dans la longévité. Certaines de ses collections vivent depuis quelques dizaines d’années. Son travail a déjà été récompensé de nombreux prix de design. Le style de Mikaëla Dörfel fait preuve d’une élégance atemporelle, innovant et qui reste pourtant toujours excessivement pratique.

De

Nach Ansicht von Mikaëla Dörfel „muss jedes Design seine eigene Persönlichkeit besitzen“. Mikaëla Dörfel ist in Finnland aufgewachsen, woher sie sich eine Vorliebe für skandinavische Formen bewahrt hat. Sie hat sich in einem alten Bauernhaus, umgeben von Pferden und Weiden mit verstreuten Weihern niedergelassen. Die Inspiration für ihr Design kommt unmittelbar aus der Natur und stützt sich auf eine klare Struktur. Ihr Designstudio befindet sich seit mehr als 15 Jahren im Norden von Hamburg und arbeitet für Marken in ganz Europa, Asien und den USA. „Sicher, eine Kollektion wird aus einer Idee geboren, aber dann zählt jedes Detail, um sie umzusetzen. Die Einfachheit des Konzepts und seine Klarheit machen seine Stärke aus. Das Konzept muss inspirieren, Empfindungen wachrufen, auf unabhängige Weise funktionieren und dem eingesetzten Material auf natürliche Weise gerecht werden. Ein Konzept trägt einem Verwendungszweck Rechnung und wird aus der Kombination einer Sensibilität für Formen in Verbindung mit logischen Überlegungen zur Schaffung eines Produkts geboren, das Design mit Funktionalität verbindet. Die Erstellung von Modellen ist eine sehr bedeutende Etappe bei der Gestaltung einer Kollektion, denn sie erlaubt es, jedes kleinste Detail zu perfektionieren. Mikaëla Dörfel pflegt eine taktile Herangehensweise. Sie liebt es, das Porzellan mit ihren Fingern zu erspüren, um die Funktionalität der Formen für die tägliche Verwendung zu prüfen. „Fehler sind manchmal leichter durch Anfassen zu entdecken.“ Mikaëla Dörfel möchte der Qualität des eingesetzten Materials gerecht werden. Ihr moderner und eleganter Stil versucht Spannungslinien und Kurven harmonisch miteinander zu verbinden. Ihre Intuition für Formen geht mit ihren umfassenden Kenntnissen über Materialien und alte oder moderne Produktionsverfahren einher. Mikaëla Dörfel kennt die Materialien und die Märkte. Kreativität und Anspruch kennzeichnen ihre Arbeit. Durch ihre Liebe für Formen hat sie Kollektionsstücke entworfen, die Modeerscheinungen umgehen und auf Langlebigkeit ausgerichtet sind. Einige ihrer Kollektionen gibt es bereits seit Jahrzehnten. Ihre Arbeit wurde schon mit zahlreichen Designpreisen ausgezeichnet. Der Stil von Mikaëla Dörfel beweist eine zeitlose, innovative Eleganz, die jedoch stets außerordentlich praktisch bleibt.

Es

Para Mikaëla Dörfel, “cada diseño debe tener su propia personalidad”. Mikaëla Dörfel creció en Finlandia, de donde nace su fascinación por las formas escandinavas. Afincada en una antigua granja rodeada de caballos y praderas llenas de estanques, su diseño se inspira directamente en la naturaleza sostenida por una estructura clara. Allí se encuentra su estudio de creación, al norte de Hamburgo, donde lleva instalada desde hace más de 15 años y donde trabaja para marcas de Europa, Asia y Estados Unidos. “Obviamente, toda colección nace a partir de una idea, pero cada detalle es importante para poder llevarla a la práctica. La simplicidad del concepto y su evidencia son su punto fuerte. El concepto debe inspirar, despertar sensaciones, funcionar de forma independiente y hacer justicia al material empleado de manera natural”. Un concepto responde a una necesidad utilitaria y nace de la combinación de una sensibilidad de las formas, unida a la reflexión lógica para crear un producto y un diseño funcional. La creación de las maquetas constituye una etapa muy importante en la elaboración de una colección, ya que permite perfeccionar cada pequeño detalle. Mikaëla Dörfel aboga por un enfoque táctil. Adora sentir la porcelana entre sus dedos para corroborar la funcionalidad de las formas con un uso diario. “En ocasiones, los errores son más fáciles de detectar a través del tacto”. Mikaëla Dörfel pretende hacer justicia a la calidad del material empleado. Su estilo moderno y elegante busca la armonía entre líneas de tensión y líneas curvas. Su intuición para las formas va acorde con su profundo conocimiento de los materiales y de los métodos de producción antiguos o modernos. Mikaëla Dörfel conoce a la perfección los materiales y el mercado. Su trabajo se caracteriza por la creatividad y la exigencia. Su amor por las formas la lleva a crear piezas de colección que evitan las modas y que se inscriben en la longevidad. Algunas de sus colecciones perduran durante décadas. Su trabajo ha sido recompensado con numerosos premios de diseño. El estilo de Mikaëla Dörfel da fe de una elegancia atemporal, innovadora y excesivamente práctica.

It

Per Mikaëla Dörfel “ogni design deve possedere una propria personalità”. Mikaëla Dörfel è cresciuta in Finlandia, da cui ha origine il suo fascino per le forme scandinave. Stabilitasi in un’antica fattoria circondata da cavalli e praterie disseminate di stagni, il suo design s’ispira direttamente alla natura sostenuta da una struttura chiara. Il suo studio di creazione si trova a nord di Amburgo da oltre 15 anni e lavora per marchi distribuiti in Europa, Asia e Stati Uniti. “Ovviamente, una collezione prende vita da un’idea, ma ogni dettaglio diviene poi importante per la sua realizzazione. La semplicità del concetto e la sua evidenza sono la sua forza. Il concetto deve ispirarsi, risvegliare delle sensazioni, funzionare in maniera indipendente e rendere giustizia al materiale utilizzato in modo naturale”. Un concetto risponde a un’esigenza utilitaria e nasce dalla combinazione di una sensibilità delle forme, alleata al riflesso logico per creare un prodotto sia di design che funzionale. La creazione dei bozzetti rimane una tappa estremamente importante nella realizzazione di una collezione, in quanto consente di perfezionare ogni più piccolo dettaglio. Mikaëla Dörfel coltiva un approccio tattile. Ama sentire la porcellana sotto le dita per verificare la funzionalità delle forme nel loro utilizzo quotidiano. “Gli errori sono talvolta più facili da rilevare grazie al tatto”. Mikaëla Dörfel cerca di rendere giustizia alla qualità del materiale impiegato. Il suo stile elegante e moderno cerca l’armonia tra linee di tensione e curve. La sua intuizione per le forme va di pari passo con la sua conoscenza profonda dei materiali e dei metodi di produzione antichi o moderni. Mikaëla Dörfel conosce i materiali e i mercati. La sua creatività ed il rigore caratterizzano il suo lavoro. Il suo amore per le forme la porta a creare pezzi da collezione che evitano le mode in favore della longevità. Alcune delle sue collezioni sono ancora attuali da alcune decine d’anni. Il suo lavoro è già stato ricompensato da numerosi premi di design. Lo stile di Mikaëla Dörfel è prova di un’eleganza senza tempo, innovativa, che rimane comunque estremamente pratica.

En

MAREA and its array of items is a collection of large tasting plates, a sharing plate and multifunctional dishes for a truly theatrical presentation.

Fr

MAREA et son florilège d'articles regroupe des assiettes de dégustation généreuses, un plat « à partager » et des assiettes multi facettes pour une théâtralité maximale.

De

MAREA und ihre Fülle an Teilen bietet großzügige Degustationsteller, eine Platte „zum Teilen“ und facettenreiche Teller für eine maximale Wirkung.

Es

MAREA y su florilegio de artículos agrupa platos de degustación generosos, una fuente “para compartir” y platos multifacetas para una teatralidad máxima.

It

MAREA e il suo florilegio di articoli raggruppa piatti da degustazione generosi, un piatto “da condividere” e piatti multiformi per la massima teatralità.

DESIGN BY GEMMA BERNAL



ASTRO

Rectangular platter

Plat rectangulaire
Platte rechteckig
Fuente rectangular
Piatto rettangolare

MRRP35 35 x 25 cm
13 7/9 x 9 5/6"

6

MRRP25 25 x 20 cm
9 5/6 x 7 7/8"

12

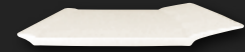

Square platter

Plat carré
Platte quadratisch
Fuente cuadrado
Piatto quadrato

MRSR25 25 cm / 9 5/6"

12

TOPTAPA

Plate

Assiette
Teller
Plato
Piatto

MRGP30 30 cm / 11 4/5"

12



Spoon

Cuillère
Löffel
Cuchara
Cucchiaio

MRSR01 12 x 5.2 cm
4 5/7 x 2"

12

SWITCH

Plate with indent

Assiette à encoche
Teller mit Fläche
Plato con estanque
Piatto con inserti

MRDP31 31 cm / 12 1/5"

6

MRDP27 27 cm / 10 5/8"

12



Goblet

Gobelet
Becher
Copa
Bicchieri

MRTB09 9 cl / 3 oz

MRTB07 7 cl / 2 3/8 oz

12

Salad bowl

Saladier
Salatschale
Ensaladera
Insalatiera

MRSB18 12.7 cm - 4 cm - 18 cl
5" - 1 4/7" - 6 oz

24



Bowl

Bol
Schale
Bol
Coppetta

MRBW30 12 cm - 6 cm - 30 cl
4 5/7 x 2 1/3" - 10 1/7 oz

MRBW13 10 cm - 4 cm - 13 cl
4" - 1 4/7" - 4 2/5 oz

12



CIRCUS

Round plate

Assiette ronde
Teller rund
Plato redondo
Piatto rotondo

MRFP30 30 cm / 11 4/5"

MRFP24 24 cm / 9 4/9"

MRFP18 18 cm / 7"

12



Oval plate

Assiette ovale
Teller oval
Plato oval
Piatto ovale

MROP18 18 x 11 cm
4 1/3 x 2"

12



Pieces per box
 Pièces par boîte
 Stück pro Karton
 Piezas por caja
 Pezzi per scatola

En

Designed by Gemma Bernal, the GIRO collection plays with the rules and takes its inspiration from the oval shape together with an off-centre design. GIRO is made up of oval, round, flat and deep plates, bowls and salad dishes and plates in different sizes, inviting you to perfect your settings mirroring the original outline.

Fr

Dessinée par Gemma Bernal, la collection GIRO se joue des règles et prend naissance dans la forme ovale associée à une composition décentrée. Composée d'assiettes ovales, rondes, plates ou creuses, de bols, de saladiers et de plats de dimensions diverses, GIRO invite à sublimer les mises en scène en épousant ses contours originaux.

De

Die von Gemma Bernal entworfene Kollektion GIRO spielt mit den Regeln und hat ihren Ursprung in der ovalen Form in Verbindung mit einer exzentrischen Komposition. GIRO besteht aus ovalen, runden, flachen oder tiefen Tellern, Schalen, Salatschalen und Platten verschiedener Größen und lädt dazu ein, die Inszenierung besonders in den Vordergrund zu rücken, indem sie den originellen Konturen angepasst wird.

Es

Diseñada por Gemma Bernal, la colección GIRO se burla de las normas y nace de la forma ovalada asociada a una composición descentrada. GIRO, compuesta de platos ovalados y redondos, tanto llanos como hondos, tazones, ensaladeras y fuentes de diversas dimensiones, invita a sublimar las puestas en escena abrazando sus contornos originales.

It

Progettata da Gemma Bernal, la collezione GIRO si prende gioco delle regole e prende vita nella forma ovale associata a una composizione decentrata. Composta da piatti ovali, tondi, piani o fondi, ciotole, insalatiere e piatti di varie misure, GIRO invita a sublimare le presentazioni sposando i suoi contorni originali.



Oval plate
Assiette ovale
Teller oval
Plato oval
Piatto ovale

GIOP39 38.7 x 31 cm
15 1/4 x 12 1/5"

GIOP36 36.2 x 29 cm
14 1/4 x 11 3/7"



GIOP34 33.7 x 27 cm
13 1/4 x 10 5/8"

GIOP30 30 x 24 cm
11 4/5 x 9 4/9"

GIOP25 25 x 20 cm
9 5/6 x 7 7/8"

GIOP17 17 x 14 cm
6 2/3 x 5 1/2"



Oval Platter
Plat ovale
Platte oval
Fuente oval
Piatto ovale

GIPL34 34 x 22 cm
13 2/5 x 8 2/3"

GIPL30 30 x 18 cm
11 4/5 x 7"

GIPL25 25 x 13 cm
9 5/6 x 5 1/8"



Round Plate
Assiette ronde
Teller rund
Plato redondo
Piatto rotondo

GIFP30 30 cm / 11 4/5"

GIFP27 27 cm / 10 5/8"

GIFP21 21 cm / 8 1/4"
GIFP18 18 cm / 7"

GIFP15 15 cm / 6"
GIFP10 10 cm / 4"



Oval deep plate
Assiette creuse ovale
Teller tief oval
Plato hondo oval
Piatto fondo ovale

GIOD29 29 x 23 cm
11 3/7 x 9"

GIOD24 24 x 19 cm
9 4/9 x 7 1/2"



Oval bowl
Bol ovale
Schale oval
Bol oval
Coppetta ovale

GIQB26 26 x 20.3 cm - 7.8 cm
10 1/4 x 8" - 3"

GIQB23 22.9 x 18 cm - 6.5 cm
9 x 7" - 2 5/9"

GIQB20 20.2 x 16 cm - 5.5 cm
8 x 6 2/7" - 2 1/16"



GIQB16 16.1 x 12 cm - 4.8 cm
6 1/3 x 4 5/7" - 1 8/9"



Round deep plate
Assiette creuse ronde
Teller tief rund
Plato hondo redondo
Piatto fondo rotondo

GIDP24 24 cm / 9 4/9"



Breakfast cup
Tasse à déjeuner
Frühstückstasse
Taza a desayuno
Tazza da colazione

GICU39 11.5 cm - 39 cl
4 1/2" - 13 1/5 oz



Chocolate cup
Tasse à chocolat
Schokotasse
Taza a chocolate
Tazza da cioccolata

GICU29 9.3 cm - 29 cl
3 2/3" - 9 4/5 oz



Coffee cup
Tasse à café
Kaffeetasse
Taza a café
Tazza da caffè

GICU23 8.3 cm - 23 cl
3 1/4" - 7 7/9 oz



Saucer
Soucoupe
Untere
Platillo
Piattino

GISA17 > GICU39 / GICU29 / GICU23
17 cm / 6 2/3"



Coffee cup
Tasse à café
Kaffeetasse
Taza a café
Tazza da caffè

GICU20 8 cm - 20 cl
3 1/7" - 6 3/4 oz

GICU15 7.2 cm - 15 cl
2 5/6" - 5 oz



Espresso cup
Tasse à espresso
Espressotasse
Taza a expreso
Tazza da espresso

GICU09 6 cm - 9 cl
2 1/2" - 3 oz



Saucer
Soucoupe
Untere
Platillo
Piattino

GISA14 > GICU20 / GICU15 / GICU09

14.5 cm / 5 5/7"



Oval saucer
Soucoupe ovale
Untere oval
Platillo oval
Piattino ovale

GISA29 > GICU29 / GICU23 / GICU15 / GICU09

29 x 16 cm / 11 3/7 x 6 2/7"





Coffee pot
Cafetière
Kaffekanne
Cafetera
Caffettiera
GICP35 35 d / 11 5/6 oz
6



Sugar bowl
Sucrier
Zuckerdose
Azucarero
Zuccheriera
GISU01 8.5 cm - 7.8 cm
3 1/3" - 3"
12



Teapot
Théière
Teekanne
Tetera
Teiera
GITP40 40 d / 13 1/2 oz
6



Sugar pack holder
Sucrier sachets
Zuckertütenschale
Azucarero sobres
Portabustine da zucchero
GISH01 11.5 cm - 5 cm
4 1/2" - 2"
12



Jug
Carafe
Krug
Jarra
Caraffa
GIJU100 100 d / 33 4/5 oz
4
GIJU50 50 d / 17 oz
6
GIJU25 25 d / 8 4/9 oz
12



Jug / Creamer
Carafe / Crémier
Krug / Milchkännchen
Jarra / Lechera
Caraffa/bricco da latte
GIJU15 15 d / 5 oz
GIJU09 9 d / 3 oz
12



En

BARISTA offers a range of cups in all sizes, manufactured using our exclusive material, highly effective at retaining temperature. The ergonomically-designed handles are easy to hold and six of the seven cups can be combined with the same saucer, to help control outlay and storage costs.

Fr

BARISTA offre un éventail de tasses de toutes tailles fabriquées dans notre matériau exclusif conservant les températures à merveille. Ses anses ergonomiques permettent une manipulation aisée et six des sept tasses se combinent avec la même sous-tasse, de sorte que l'investissement et les coûts de stockage sont maîtrisés.

De

BARISTA bietet ein großes Spektrum an Tassen aller Größen, die aus unserem exklusiven Material hergestellt sind, das die Temperatur besonders gut hält. Durch ihre ergonomischen Henkel können sie bequem gehalten und sechs von sieben Tassen können mit derselben Untertasse kombiniert werden, so dass Anschaffungs- und Lagerkosten in Grenzen gehalten werden.

Es

BARISTA ofrece una amplia variedad de tazas de todos los tamaños fabricadas a base de nuestro material exclusivo que conserva la temperatura a la perfección. Sus asas ergonómicas permiten una fácil manipulación y seis de sus siete tazas se combinan con el mismo plato, para así reducir la inversión y los costes de almacenaje.

It

BARISTA offre una gamma di tazze di tutte le misure fabbricate nel nostro esclusivo materiale che conserva perfettamente le temperature. Le sue anse ergonomiche consentono una facile manipolazione e sei delle sette tazze possono essere combinate con la stessa sotto-tazza, in modo da ammortizzare l'investimento e i costi di stoccaggio.



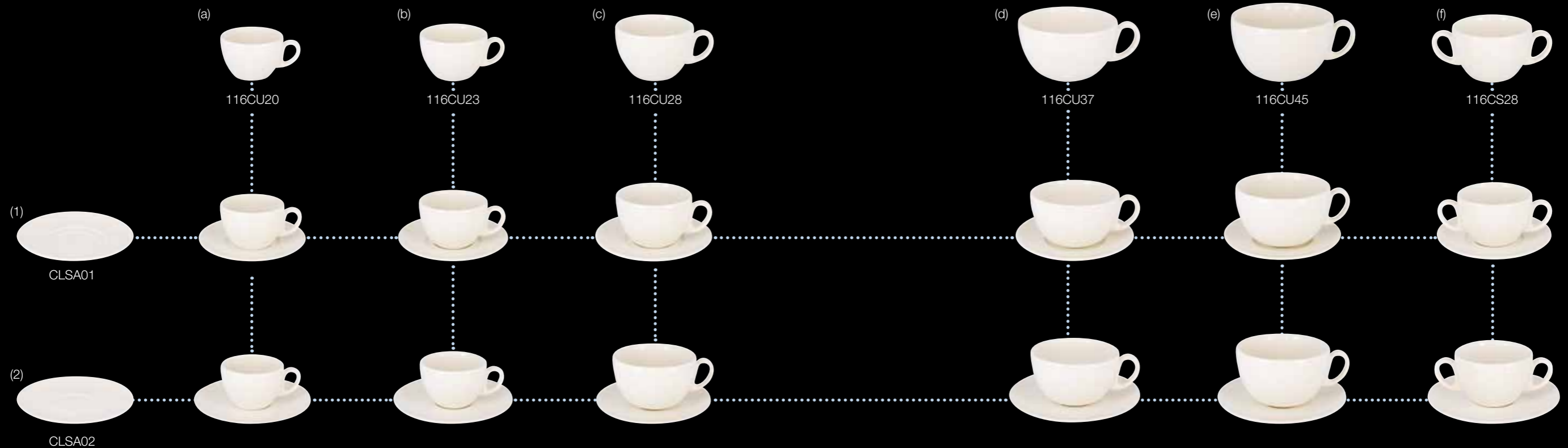

(1) **Universal Saucer**
Soucoupe universelle
Kombi Untere
Platillo universal
Piattino universale
CLSA01 15 cm / 6"
12

(a) **Coffee cup 20 cl**
Tasse à café
Kaffeetasse
Taza a café
Tazza da caffè
116CU20 H 6 cm - 20 cl
2 1/3" - 6 3/4 oz
12

(d) **Breakfast cup 37 cl**
Tasse à déjeuner
Frühstücktasse
Taza a desayuno
Tazza da colazione
116CU37 H 6.7 cm - 37 cl
2 2/3" - 12 1/5 oz
12

(2) **Universal Saucer**
Soucoupe universelle
Kombi Untere
Platillo universal
Piattino universale
CLSA02 17 cm / 6 2/3"
12

(b) **Coffee cup 23 cl**
Tasse à café
Kaffeetasse
Taza a café
Tazza da caffè
116CU23 H 6.1 cm - 23 cl
2 2/5" - 7 7/9 oz
12

(e) **Breakfast cup 45 cl**
Tasse à déjeuner
Frühstücktasse
Taza a desayuno
Tazza da colazione
116CU45 H 7.5 cm - 45 cl
3" - 15 2/9 oz
12

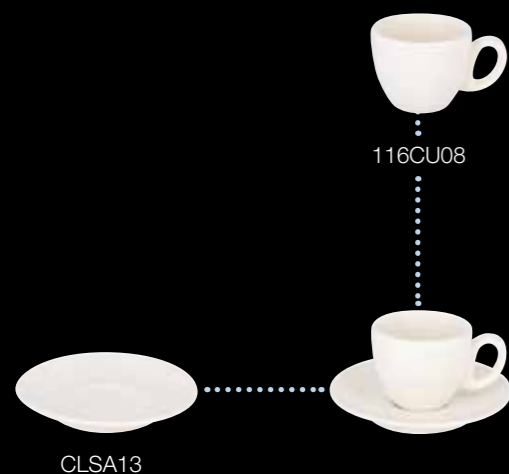

Saucer for espresso cup
Soucoupe pour tasse à espresso
Untere für espressotasse
Platillo para taza a expreso
Piattino per tazza da espresso
CLSA13 13 cm / 5 1/8"
12

Espresso cup
Tasse à espresso
Espressotasse
Taza a expreso
Tazza da espresso
116CU08 H 5.3 cm - 8 cl
2" - 2 5/7 oz
12

(c) **Coffee cup 28 cl**
Tasse à café
Kaffeetasse
Taza a café
Tazza da caffè
116CU28 H 6.3 cm - 28 cl
2 1/2" - 9 1/2 oz
12

(f) **Cream soup bowl, 2 handles**
Tasse à bouillon, 2 anses
Suppentasse, 2 Henkel
Bol consommé, 2 asas
Scodella per zuppa, 2 manici
116CS28 H 6.3 cm - 28 cl
2 1/2" - 9 1/2 oz
12

En

PEPPERY is a collection with rustic-style enamel decoration, available in four colours that can be mixed and matched. The complete range, particularly including coffee and buffet service pieces, reflects the current trend for natural materials, with a terracotta and earthenware theme reminiscent of traditional dining tables.

Fr

PEPPERY est une collection décorée sous émail, aux accents rustiques déclinée en quatre teintes combinables. Sa gamme complète comprenant notamment des pièces pour la cafétéria et les buffets s'inscrit dans la tendance actuelle des matières naturelles et d'une atmosphère terre cuite qui fait référence aux tables traditionnelles.

De

PEPPERY ist eine unter der Glasur dekorierte Kollektion mit rustikalen Akzenten in vier kombinierbaren Farbtönen. Die vollständige Kollektion umfasst insbesondere Hohl- und Buffeteile und trägt dem aktuellen Trend für natürliche Materialien und einer traditionellen Tischatmosphäre mit Ton und Steingut Rechnung.

Es

PEPPERY es una colección decorada a base de esmalte, con toques rústicos y declinada en cuatro colores combinables. Su gama completa incluye piezas para cafetería y bufés, y se inscribe en la tendencia actual de materiales naturales y de una atmósfera de terracota que hace referencia a las mesas tradicionales.

It

PEPPERY è una collezione decorata in sotto-smalto, dagli accenti rustici declinata in quattro tinte combinabili. La sua gamma completa, comprendente in particolare pezzi per la caffetteria e i buffet, si inserisce nella tendenza attuale dei materiali naturali e di un'atmosfera in terracotta e ceramica che ricorda le tavole tradizionali.





Flat coupe plate
Assiette coupe plate
Teller flach coupe
Plato llano coupe
Piatto piano senza falda

NNPR31PGY 31 cm / 12 1/5"



NNPR27PGY 27 cm / 10 5/8"

NNPR24PGY 24 cm / 9 4/9"

NNPR21PGY 21 cm / 8 1/4"



NNPR18PGY 18 cm / 7"

NNPR15PGY 15 cm / 6"



Square plate
Assiette carrée
Teller quadratisch
Plato cuadrado
Piatto quadrato

EDSQ30PGY 30 cm / 11 8/9"



EDSQ27PGY 27 cm / 10 5/8"

EDSQ25PGY 24.5 cm / 9 2/3"



Rectangular serving plate
Assiette à servir rectangulaire
Servierteller rechteckig
Plato para servir rectangular
Piatto da portata rettangolare

EDRG33PGY 33.5 x 18.1 cm
13 1/5 x 7 1/8"



Oval platter
Plat ovale
Platte oval
Fuente oval
Piatto ovale

NNOP36PGY 36 x 27 cm
14 1/6 x 10 5/8"

NNOP32PGY 32 x 23 cm
12 3/5 x 9"



NNOP26PGY 26 x 19 cm
10 1/4 x 7 1/2"

NNOP21PGY 21 x 15 cm
8 1/4 x 6"



Bowl
Bol
Schale
Bol
Coppetta

BABW12PGY 12 cm - 6 cm - 48 cl
4 5/7" - 2 1/3" - 16 2/9 oz



BACS01PGY 10 cm - 5.8 cm - 30 cl
4" - 2 2/7" - 10 1/7 oz



Mug
Chope
Becher
Mug
Mug

BAFMG30PGY 8 cm - 10.8 cm - 30 cl
3 1/7" - 4 1/4" - 10 1/7 oz

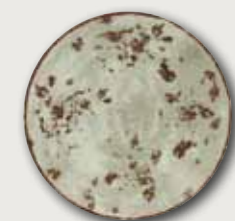

Coupe bowl
Bol coupe
Schale coupe
Bol coupe
Coppetta senza falda

BUBC30PGY 30 cm - 190 cl
11 4/5" - 64 1/4 oz



BUBC26PGY 26 cm - 120 cl
10 1/4" - 40 4/7 oz



Tea/coffee cup
Tasse à thé/café
Tee- /Kaffeetasse
Taza a té/café
Tazza da tè/caffè

BACU23PGY 8.6 cm - 6 cm - 23 cl
3 2/5" - 2 1/3" - 7 7/9 oz



Saucer for tea/coffee cup
Soucoupe pour tasse à thé/café
Untere für Tee- /Kaffeetasse
Platillo para taza a té/café
Piatino per tazza da tè/caffè

BASA15PGY 15 cm / 6"



Espresso cup
Tasse à espresso
Espressotasse
Taza a expreso
Tazza da espresso

BACU09PGY 6 cm - 5.5 cm - 9 cl
2 1/3" - 2 1/6" - 3 oz



Saucer for espresso cup
Soucoupe pour tasse à espresso
Untere für Espressotasse
Platillo para taza a expreso
Piatino per tazza da espresso

BASA13PGY 13 cm / 5 1/8"





Flat coupe plate
Assiette coupe plate
Teller flach coupe
Plato llano coupe
Piatto piano senza falda

NNPR31PBL 31 cm / 12 1/5"



NNPR27PBL 27 cm / 10 5/8"

NNPR24PBL 24 cm / 9 4/9"

NNPR21PBL 21 cm / 8 1/4"



NNPR18PBL 18 cm / 7"

NNPR15PBL 15 cm / 6"

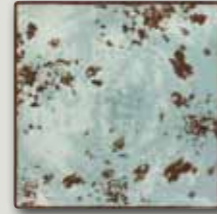

Square plate
Assiette carrée
Teller quadratisch
Plato cuadrado
Piatto quadrato

EDSQ30PBL 30 cm / 11 8/9"



EDSQ27PBL 27 cm / 10 5/8"

EDSQ25PBL 24.5 cm / 9 2/3"



Rectangular serving plate
Assiette à servir rectangulaire
Servierteller rechteckig
Plato para servir rectangular
Piatto da portata rettangolare

EDRG33PBL 33.5 x 18.1 cm
13 1/5 x 7 1/8"

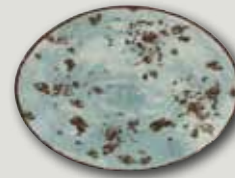

Oval platter
Plat ovale
Platte oval
Fuente oval
Piatto ovale

NNOP36PBL 36 x 27 cm
14 1/6 x 10 5/8"

NNOP32PBL 32 x 23 cm
12 3/5 x 9"



NNOP26PBL 26 x 19 cm
10 1/4 x 7 1/2"

NNOP21PBL 21 x 15 cm
8 1/4 x 6"



Coupe bowl
Bol coupe
Schale coupe
Bol coupe
Coppetta senza falda

BUBC30PBL 30 cm - 190 cl
11 4/5" - 64 1/4 oz



BUBC26PBL 26 cm - 120 cl
10 1/4" - 40 4/7 oz



Bowl
Bol
Schale
Bol
Coppetta

BABW12PBL 12 cm - 6 cm - 48 cl
4 5/7" - 2 1/3" - 16 2/9 oz



BACS01PBL 10 cm - 5.8 cm - 30 cl
4" - 2 2/7" - 10 1/7 oz



Mug
Chope
Becher
Mug
Mug

BAFMG30PBL 8 cm - 10.8 cm - 30 cl
3 1/7" - 4 1/4" - 10 1/7 oz



Tea/coffee cup
Tasse à thé/café
Tee- /Kaffeetasse
Taza a té/café
Tazza da tè/caffè

BACU23PBL 8.6 cm - 6 cm - 23 cl
3 2/5" - 2 1/3" - 7 7/9 oz



Saucer for tea/coffee cup
Soucoupe pour tasse à thé/café
Untere für Tee- /Kaffeetasse
Platillo para taza a té/café
Piattino per tazza da tè/caffè

BASA15PBL 15 cm / 6"



Espresso cup
Tasse à espresso
Espressotasse
Taza a espresso
Tazza da espresso

BACU09PBL 6 cm - 5.5 cm - 9 cl
2 1/3" x 2 1/6" - 3 oz



Saucer for espresso cup
Soucoupe pour tasse à espresso
Untere für Espressotasse
Platillo para taza a espresso
Piattino per tazza da espresso

BASA13PBL 13 cm / 5 1/8"





Flat coupe plate
Assiette coupe plate
Teller flach coupe
Plato llano coupe
Piatto piano senza falda

NNPR31PBR 31 cm / 12 1/5"



NNPR27PBR 27 cm / 10 5/8"

NNPR24PBR 24 cm / 9 4/9"

NNPR21PBR 21 cm / 8 1/4"



NNPR18PBR 18 cm / 7"

NNPR15PBR 15 cm / 6"



Square plate
Assiette carrée
Teller quadratisch
Plato cuadrado
Piatto quadrato

EDSQ30PBR 30 cm / 11 8/9"



EDSQ27PBR 27 cm / 10 5/8"

EDSQ25PBR 24.5 cm / 9 2/3"



Rectangular serving plate
Assiette à servir rectangulaire
Servierteller rechteckig
Plato para servir rectangular
Piatto da portata rettangolare

EDRG33PBR 33.5 x 18.1 cm
13 1/5 x 7 1/8"



Bowl
Bol
Schale
Bol
Coppetta

BABW12PBR 12 cm - 6 cm - 48 cl
4 5/7" - 2 1/3" - 16 2/9 oz



BACS01PBR 10 cm - 5.8 cm - 30 cl
4" - 2 2/7" - 10 1/7 oz



Mug
Chope
Becher
Mug
Mug

BAFMG30PBR 8 cm - 10.8 cm - 30 cl
3 1/7" - 4 1/4" - 10 1/7 oz



Oval platter
Plat ovale
Platte oval
Fuente oval
Piatto ovale

NNOP36PBR 36 x 27 cm
14 1/6 x 10 5/8"

NNOP32PBR 32 x 23 cm
12 3/5 x 9"



NNOP26PBR 26 x 19 cm
10 1/4 x 7 1/2"

NNOP21PBR 21 x 15 cm
8 1/4 x 6"



Coupe bowl
Bol coupe
Schale coupe
Bol coupe
Coppetta senza falda

BUBC30PBR 30 cm - 190 cl
11 4/5" - 64 1/4 oz



BUBC26PBR 26 cm - 120 cl
10 1/4" - 40 4/7 oz



Tea/coffee cup
Tasse à thé/café
Tee- /Kaffeetasse
Taza a té/café
Tazza da tè/caffè

BACU23PBR 8.6 cm - 6 cm - 23 cl
3 2/5" - 2 1/3" - 7 7/9 oz



Saucer for tea/coffee cup
Soucoupe pour tasse à thé/café
Untere für Tee- /Kaffeetasse
Platillo para taza a té/café
Piatolino per tazza da tè/caffè

BASA15PBR 15 cm / 6"



Espresso cup
Tasse à espresso
Espressotasse
Taza a espresso
Tazza da espresso

BACU09PBR 6 cm - 5.5 cm - 9 cl
2 1/3" - 2 1/6" - 3 oz



Saucer for espresso cup
Soucoupe pour tasse à espresso
Untere für Espressotasse
Platillo para taza a espresso
Piatolino per tazza da espresso

BASA13PBR 13 cm / 5 1/8"



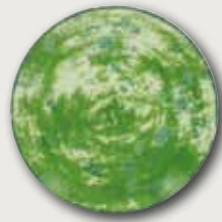

Flat coupe plate
Assiette coupe plate
Teller flach coupe
Plato llano coupe
Piatto piano senza falda

NNPR31PGN 31 cm / 12 1/5"



NNPR27PGN 27 cm / 10 5/8"

NNPR24PGN 24 cm / 9 4/9"

NNPR21PGN 21 cm / 8 1/4"



NNPR18PGN 18 cm / 7"

NNPR15PGN 15 cm / 6"

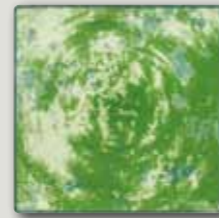

Square plate
Assiette carrée
Teller quadratisch
Plato cuadrado
Piatto quadrato

EDSQ30PGN 30 cm / 11 8/9"



EDSQ27PGN 27 cm / 10 5/8"

EDSQ25PGN 24.5 cm / 9 2/3"



Rectangular serving plate
Assiette à servir rectangulaire
Servierteller rechteckig
Plato para servir rectangular
Piatto da portata rettangolare

EDRG33PGN 33.5 x 18 cm
13 1/5 x 7 1/8"

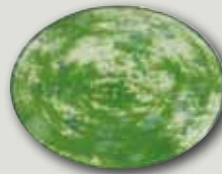

Oval platter
Plat ovale
Platte oval
Fuente oval
Piatto ovale

NNOP36PGN 36 x 27 cm
14 1/6 x 10 5/8"

NNOP32PGN 32 x 23 cm
12 3/5 x 9"



NNOP26PGN 26 x 19 cm
10 1/4 x 7 1/2"

NNOP21PGN 21 x 15 cm
8 1/4 x 6"



Bowl

Bol
Schale
Bol
Coppetta

BABW12PGN 12 cm - 6 cm - 48 cl
4 5/7" - 2 1/3" - 16 2/9 oz



BACS01PGN 10 cm - 5.8 cm - 30 cl
4" - 2 2/7" - 10 1/7 oz



Mug

Chope
Becher
Mug
Mug

BAFMG30PGN 8 cm - 10.8 cm - 30 cl
3 1/7" - 4 1/4" - 10 1/7 oz

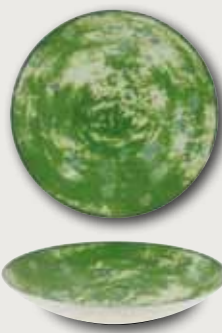

Coupe bowl
Bol coupe
Schale coupe
Bol coupe
Coppetta senza falda

BUBC30PGN 30 cm - 190 cl
11 4/5" - 64 1/4 oz



BUBC26PGN 26 cm - 120 cl
10 1/4" - 40 4/7 oz



Tea/coffee cup
Tasse à thé/café
Tee- /Kaffeetasse
Taza a té/café
Tazza da tè/caffè

BACU23PGN 8.6 cm - 6 cm - 23 cl
3 2/5" - 2 1/3" - 7 7/9 oz



Saucer for tea/coffee cup
Soucoupe pour tasse à thé/café
Untere für Tee- /Kaffeetasse
Platillo para taza a té/café
Piattino per tazza da tè/caffè

BASA15PGN 15 cm / 6"



Espresso cup
Tasse à expresso
Espressotasse
Taza a expreso
Tazza da espresso

BACU09PGN 6 cm - 5.5 cm - 9 cl
2 1/3" - 2 1/6" - 3 oz



Saucer for espresso cup
Soucoupe pour tasse à expresso
Untere für Espressotasse
Platillo para taza a expreso
Piattino per tazza da espresso

BASA13PGN 13 cm / 5 1/8"



Pieces per box
Pièces par boîte
Stück pro Karton
Piezas por caja
Pezzi per scatola



En

Bring character and that personal touch to your establishment with these service plates. They were created by RAK Porcelain's design studios and were made with the utmost care in our factory's decorating workshops.

Fr

Donnez une touche personnelle et davantage de caractère à votre établissement avec les assiettes de présentation. Créées par les studios graphiques de RAK Porcelaine elles sont réalisées avec le plus grand soin dans les ateliers de décoration de notre usine.

De

Bringen Sie mit diesen Servierplatten Charakter und eine ganz persönliche Note in Ihre Einrichtung. Sie wurden von den RAK Porzellan Design-Studios entworfen und in den Gestaltungswerkstätten unserer Fabrik mit höchster Sorgfalt hergestellt.

Es

Imprima un carácter especial y un toque de personalidad a su establecimiento con estos platos para servir. Creados por el estudio de diseño de RAK Porcelain y elaborados con la mayor dedicación en nuestros propios talleres de decoración.

It

Dai un tono e un tocco personale alla tua attività con questo servizio di piatti. Sono stati pensati dai design studio di RAK Porcelain e realizzati con la massima cura nei nostri laboratori di decorazione in azienda.

MEADOW



EMOTION

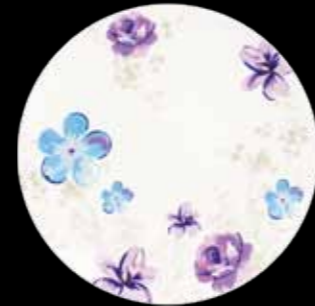

LOUNGE GREY

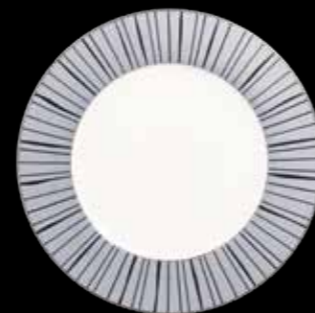

LOUNGE GREY (detail)



GRANDEUR

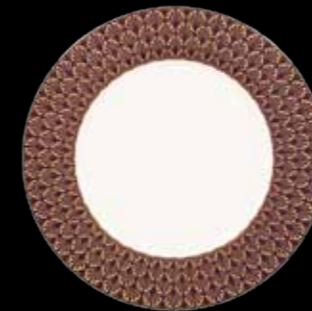

GRANDEUR (detail)



KARMA



DESTINY



SOFT 01



SOFT 02



INSPIRE



SUPREME



WOODLOOK 01

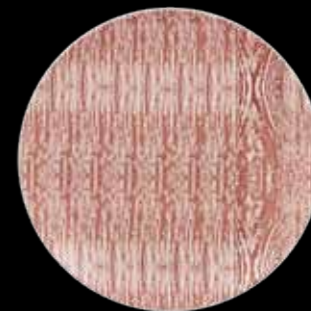

WOODLOOK 02

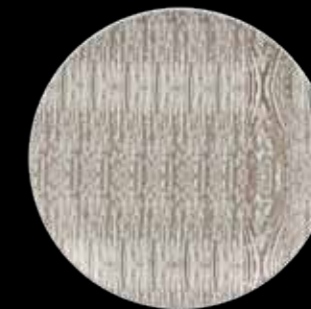

WOODLOOK 02 (detail)

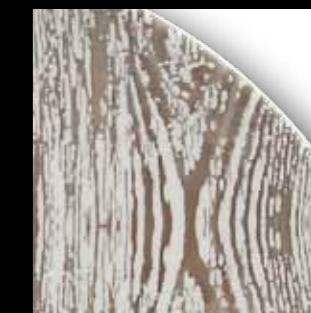

SUBLIME



⌚ These items or collections are custom made, so please allow additional time for delivery.

Ces articles ou collections sont produits à la demande, prévoir un délai d'approvisionnement supplémentaire.

Diese Artikel oder Kollektionen werden entsprechend der Nachfrage hergestellt, eine zusätzliche Lieferzeit einplanen.

Estos artículos o colecciones se fabrican en función de la demanda. Debe fijarse un período de abastecimiento adicional.

Questi articoli o collezioni sono prodotti su richiesta, si prega di quindi di prevedere un termine di consegna supplementare.

GRACE



VISION



CHATEAU



GRANDE TABLE



VISION (detail)

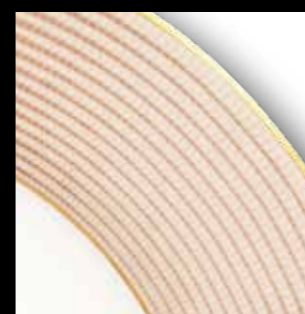

CHATEAU (detail)



GRANDE TABLE (detail)



UNICORN



VIBRATION



GRACE



UNICORN (detail)



VIBRATION (detail)



GRACE (detail)



VISION



INTERCONNECT



TONES 01



TONES 02



TONES 03

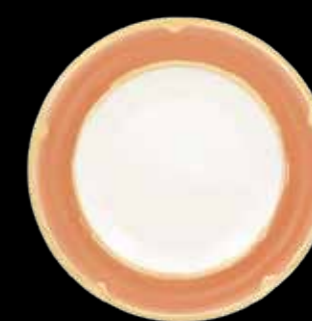

TONES 01 (detail)



TONES 02 (detail)

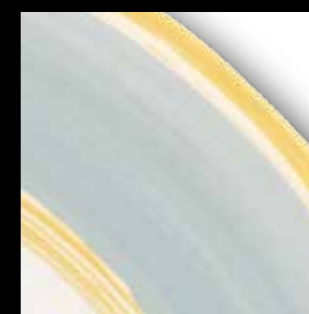

TONES 03 (detail)



TERRA



INTERCONNECT



SENSES



TERRA (detail)



INTERCONNECT (detail)



SENSES (detail)



 These items or collections are custom made, so please allow additional time for delivery.
Ces articles ou collections sont produits à la demande, prévoir un délai d'approvisionnement supplémentaire.
Diese Artikel oder Kollektionen werden entsprechend der Nachfrage hergestellt, eine zusätzliche Lieferzeit einplanen.
Estos artículos o colecciones se fabrican en función de la demanda. Debe fijarse un periodo de abastecimiento adicional.
Questi articoli o collezioni sono prodotti su richiesta, si prega di quindi di prevedere un termine di consegna supplementare.

En

Discover the know-how of our design studios for worldwide customers. We realize for you in our factory all of your customization project.

Fr

Découvrez le savoir-faire de nos studios de création pour des clients à travers le monde. Nous réalisons pour vous dans notre usine la totalité de votre projet de personnalisation.

De

Entdecken Sie das Know-how unserer Design-Studios für weltweite Kunden. Wir verwirklichen für Sie alle Ihre Personalisierungsprojekte in unserem Werk.

Es

Descubra el know-how de nuestros estudios de diseño para los clientes en todo el mundo. Fabricamos en nuestras comodidades la totalidad de su proyecto de personalización.

It

Scopri il know-how dei nostri studi di progettazione per clienti di tutto il mondo. Realizziamo per voi nel nostro stabilimento tutto il vostro progetto di personalizzazione.

WALDORF ASTORIA



SFERA



LE MAS VALENTINE



LE NORD PAUL BOCUSE



BIANCALANI



PARK INN HOTELS



FLOWERS



THE BAGEL BAR



CARLTON LYON



DADDY'S DINNER



RESTOPOLIS



HOTEL LE DARCY



THERMES DE SAINT-MALO



VICTORY HOTEL



IRISH PARLIAMENT



KEMPINSKI STEAK HOUSE



DINEA RESTAURANTS



TEPPAN



GEORGE ZÜRICH



STARS FOOD AND ART



MATT MULLICAN 01



MATT MULLICAN 02



COLLECTION
ALLSPICE

INSPIRATIONAL DINING

59

En

The sleek, pioneering style of the ALLSPICE collection is the perfect match for sophisticated culinary creations.

Fr

Le style épuré et novateur de la collection ALLSPICE est propice à des créations culinaires sophistiquées.

De

Der schlichte und moderne Stil der Kollektion ALLSPICE unterstützt die Komplexität Ihrer kulinarischen Kreationen.

Es

El estilo depurado e innovador de la colección ALLSPICE es perfecto para las creaciones culinarias más sofisticadas.

It

Lo stile essenziale e innovativo della collezione ALLSPICE si addice a delle creazioni culinarie sofisticate.



CHIVES



Square plate, 3 round indents
Assiette carrée,
3 encoches rondes
Teller quadratisch,
3 runde Flächen
Plato cuadrado,
3 estanques redondos
Piatto quadrato,
3 inserti rotonde

SPCH30 30 cm / 11 4/5"
6



Round bowl
Bol rond
Schale rund
Bol redondo
Coppetta rotonda

SPCB32 14 cm - 3.5 cm - 32 cl
5 1/2" - 1 3/8" - 10 4/5 oz

SPCB20 11 cm - 3.5 cm - 20 cl
4 1/3" - 1 3/8" - 6 3/4 oz

SPCB11 8 cm - 3.5 cm - 11 cl
3 1/7" - 1 3/8" - 3 5/7 oz

6



Cover for plate
Cloche pour assiette
Cloche für Teller
Campana para plato
Coperchio per piatto

SPLD01 13 cm / 5 1/8"
6

ANGELICA



Square plate, 2 oval indents
Assiette carrée, 2 encoches ovales
Teller quadratisch, 2 ovale Flächen
Plato cuadrado, 2 estanques ovales
Piatto quadrato, 2 inserti ovale

SPAN30 30 cm / 11 4/5"
6

FENNEL



Square plate, 2 half-moon indents
Assiette carrée,
2 encoches demi-lune
Teller quadratisch,
2 Flächen Halbmond
Plato cuadrado,
2 estanques media luna
Piatto quadrato,
2 inserti mezzaluna

SPFN30 30 cm / 11 4/5"
6

LAVENDER



Square plate, 1 oval indent
Assiette carrée, 1 encoche ovale
Teller quadratisch, 1 ovale Fläche
Plato cuadrado, 1 estanque oval
Piatto quadrato, 1 inserto ovale

SPLV30 30 cm / 11 4/5"
6

TARRAGON



Square plate, 4 compartments
Assiette carrée, 4 compartiments
Teller quadratisch, 4 Vertiefungen
Plato cuadrado, 4 compartimentos
Piatto quadrato, 4 compartimenti

SPSP4B 30 cm / 11 4/5"
6

THYME



Rectangular tray, 3 compartments
Plat rectangulaire,
3 compartiments
Platte rechteckig,
3 Vertiefungen
Fuente rectangular,
3 compartimentos
Vassoio rettangolare,
3 compartimenti

SPRP3B 38 x 18 cm
15 x 7"
6

CURRY



Square tray, 4 compartments
Plat carré, 4 compartiments
Platte quadratisch, 4 Vertiefungen
Fuente cuadrado, 4 compartimentos
Vassoio quadrato, 4 compartimenti

SPSP4I 30 cm / 11 4/5"
6



PAPRIKA



Rectangular tray, 3 compartments
Plat rectangulaire,
3 compartiments
Platte rechteckig,
3 Vertiefungen
Fuente rectangular,
3 compartimentos
Vassoio rettangolare,
3 compartimenti

SPRP3I 37 x 12.5 cm
14 4/7 x 5"
6

ANIS



Rectangular tray for 4 cups without handle
Plat rectangulaire pour
4 tasses sans anse
Platte rechteckig für
4 Tassen ohne Henkel
Fuente rectangular para
4 tazas sin asa
Vassoio rettangolare per
4 tazze senza manici

SPRP4BW 36 x 11 cm
14 1/6 x 4 1/3"
6

JUNIPER



Rectangular tray for 3 cups without handle
Plat rectangulaire pour
3 tasses sans anse
Platte rechteckig für
3 Tassen ohne Henkel
Fuente rectangular para
3 tazas sin asa
Vassoio rettangolare per
3 tazze senza manici

SPRP3BW 30 x 11 cm
11 4/5 x 4 1/3"
6





MUSTARD

Rectangular tray for 4 cups 7 cl without handle
Plat rectangulaire pour 4 tasses 7 cl sans anse
Platte rechteckig für 4 Tassen 7 cl ohne Henkel
Fuente rectangular para 4 tazas 7 cl sin asa
Vassoio rettangolare per 4 tazze 7 cl senza manici

SPRP4BI 37 x 11 cm
14 1/2 x 4 1/3"



CINNAMON

Rectangular plate, 1 round indent
Plat rectangulaire, 1 encoche ronde
Teller rechteckig, 1 runde Fläche
Plato rectangular, 1 estanque redondo
Piatto rettangolare, 1 inserto rotondo

SPRR29 29 x 22 cm
11 3/7 x 8 2/3"



SESAME

Square plate, 1 rectangular indent
Assiette carrée, 1 encoche rectangulaire
Teller quadratisch, 1 rechteckige Fläche
Plato cuadrado, 1 estanque rectangular
Piatto quadrato, 1 inserto rettangolare

SPDP30 30 cm / 11 4/5"



SPDP19 19 cm / 7 1/2"



PEPPERMINT

Square plate, 1 oval indent
Assiette carrée, 1 bassin ovale
Teller quadratisch, 1 ovale Fläche
Plato cuadrado, 1 estanque oval
Piatto quadrato, 1 inserto ovale

SPSO30 30 cm / 11 4/5"



BASIL

Cup without handle
Tasse sans anse
Tasse ohne Henkel
Taza sin asa
Tazza senza manici

SPCU09 9 d / 3 oz
SPCU07 7 d / 2 3/8 oz



CORIANDRE

Rectangular plate, 1 square indent
Assiette rectangulaire, 1 encoche carrée
Teller rechteckig, 1 quadratische Fläche
Plato rectangular, 1 estanque cuadrado
Piatto rettangolare, 1 inserto quadrato

SPRS29 29 x 22 cm
11 3/7 x 8 2/3"



CILANTRO

Round flat plate
Assiette plate ronde
Teller flach rund
Plato llano redondo
Piatto piano rotondo

SPCP29 29 cm / 11 3/7"



TAMARIND

Oval plate, 1 rectangular indent
Plat ovale, 1 encoche rectangulaire
Platte oval, 1 rechteckige Fläche
Fuente oval, 1 estanque rectangular
Piatto ovale, 1 inserto rettangolare

SPTM30 30 x 12 cm
11 4/5 x 4 5/7"

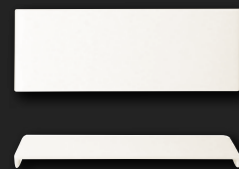

PEPPER

Rectangular presentation tray
Plat rectangulaire de présentation
Präsentationsplatte rechteckig
Fuente rectangular de presentación
Vassoio da portata rettangolare

SPRP30 30 x 11 cm
11 4/5 x 4 1/3"

SPRP17 17 cm x 12 cm
6 6/7 x 4 4/5"



VANILLA

Oval flat plate
Assiette plate ovale
Teller flach oval
Plato llano oval
Piatto piano ovale

SPEY35 35 x 26 cm / 13 7/9 x 10 1/4"



SPEY19 19 x 14 cm / 7 1/2 x 5 1/2"



CAYENNE

Oval flat plate
Assiette plate ovale
Teller flach oval
Plato llano oval
Piatto piano ovale

SPEG36 34 x 28 cm / 13 2/5 x 11"



SPEG19 19 x 16 cm / 7 1/2 x 6 2/7"



GINGER

Square plate

Assiette carrée
Teller quadratisch
Plato cuadrado
Piatto quadrato

SPSP29 29 cm / 11 3/7"



SPSP27 27 cm / 10 5/8"



SPSP25 25 cm / 9 5/6"



SPSP21 21 cm / 8 1/4"



SPSP14 14 cm / 5 1/2"



WASABI

Rectangular plate

Plat rectangulaire
Platte rechteckig
Fuente rectangular
Piatto rettangolare

SPRP28 28 x 14 cm

11 x 5 1/2"

SPRP25 25 x 12.5 cm

10 x 5"

OPSP24 24 x 14 cm

9 4/9 x 5 1/2"



Rectangular tray, 2 indents*

Plat rectangulaire, 2 empreintes*
Platte rechteckig, 2 Ringe*
Fuente rectangular, 2 estanques*
Vassoio rettangolare, 2 inserti*

SPRP28IN 28 x 14 cm

11 x 5 1/2"

SPRP18IN 18 x 14 cm

7 x 5 1/2"



Rectangular tray, 3 indents*

Plat rectangulaire, 3 empreintes*
Platte rechteckig, 3 Ringe*
Fuente rectangular, 3 estanques*
Vassoio rettangolare, 3 inserti*

SPRP24IN 24 x 14 cm

9 4/9 x 5 1/2"



CHILLI

Bowl

Bol
Schale
Bol
Coppetta

SPCU18 7.5 cm - 6 cm - 18 cl

3" - 2 1/3" - 6 oz



NIGELLA

Crater bowl

Kratère
Kratèr Schale
Bol crater
Coppetta cratere

SPCB33 22.5 cm - 7 cm - 33 cl

8 5/6" - 2 3/4" - 11 3/5 oz

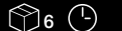

Fountain bowl

Bol fontaine
Fontäne Schale
Bol fuente
Coppetta fontana

SPFB33 22.5 cm - 7 cm - 33 cl

8 7/9" - 2 5/7" - 11 3/5 oz

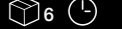

BEAN

Coffee cup

Tasse à café
Kaffeetasse
Taza a café
Tazza da caffè

SPCU27 5.3 cm - 27 cl

2" - 9 1/2 oz



Saucer

Soucoupe
Untere
Platillo
Piattino

SPSA14 14.2 cm / 5 3/5"

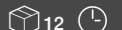

Extra time for deliveries
Délai supplémentaire
Zusätzliche Lieferzeit
Período de abastecimiento adicional
Termine di consegna supplementare

CURCUMA

Square bowl

Bol carré
Schale quadratisch
Bol cuadrado
Coppetta quadrata

SPSB22 22 cm / 8 2/3"



SPSB15 15 cm / 6"

SPSB13 13 cm / 5 1/8"



SAFFRON

Rectangular bowl

Bol rectangulaire
Schale rechteckig
Bol rectangular
Coppetta rettangolare

SPRB19 19 cm x 14.5 cm - 50 cl

7 1/2 x 5 3/4" - 17 3/5 oz



Pieces per box
Pièces par boîte
Stück pro Karton
Piezas por caja
Pezzi per scatola

COLLECTION
ANNA

ELEGANT DINING

67

En

The charming ANNA collection has been created by Mikaela Dörfel to set off perfectly the delicious dishes of yesteryear and tomorrow, with its curves and contours, glorifying culinary traditions.

Fr

Créée par Mikaela Dörfel pour mettre en scène les bons petits plats d'autrefois et de demain, ANNA est une collection toute en charme et rondeurs magnifiant les traditions culinaires.

De

ANNA ist durch die Hand von Mikaela Dörfel entstanden, um die guten kleinen und großen Gerichte von gestern aber auch von morgen in Szene zu setzen. Durch die Kollektion mit ihrem Charme und ihren runden Formen kommen kulinarische Traditionen voll zur Geltung.

Es

ANNA, creada por Mikaela Dörfel para poner en escena los deliciosos platos de antaño y de mañana, es una colección curva con encanto que magnifica las tradiciones culinarias.

It

Creata da Mikaela Dörfel per mostrare lo spettacolo dei piatti di ieri e di domani, ANNA è una collezione all'insegna dell'eleganza e delle rotondità che intende esaltare le tradizioni culinarie.

DESIGN BY MIKAELA DOERFEL





Flat plate
Assiette plate
Teller flach
Plato llano
Piatto piano

ANFP31 31 cm / 12"
6

ANFP29 29 cm / 11 1/3"
ANFP27 27 cm / 10 5/8"
ANFP24 24 cm / 9 4/9"

12

ANFP21 21 cm / 8 1/9"
ANFP17 17 cm / 6 3/5"

24



Bowl
Bol
Schale
Bol
Copetta

ANBW21 21 cm - 10.5 cm - 230 cl
8 1/4" - 4 1/7" - 81 oz

4

ANBW18 18 cm - 9 cm - 140 cl
7 1/5" - 3 4/7" - 49 2/7 oz

ANBW16 16 cm - 8 cm - 100 cl
6 2/7" - 3 1/7" - 35 1/5 oz

6

ANBW14 14 cm - 5.5 cm - 48 cl
5 3/5" - 2 1/6" - 16 8/9 oz

12



Deep plate
Assiette creuse
Teller tief
Plato hondo
Piatto fondo

ANDP30 30 cm / 11 4/5"
6

ANDP26 26 cm / 10 1/3"
ANDP24 24 cm / 9 4/9"

12



NEW

Cereal Bowl
Bol à céréales
Muesli-Schale
Bol a cereales
Coppetta per cereali

ANCB13 13 cm - 8.5 cm - 63 cl
5 1/8" - 3 1/3" - 21 1/3 oz

6



Soup tureen & lid
Soupière & couvercle
Suppenterrine & Deckel
Sopera & tapa
Zuppiera & coperchio

ANSD26 26 cm - 250 cl
10 1/4" - 84 1/2 oz

ANSD23 23 cm - 230 cl
9" - 77 7/9 oz

1



Oval plate
Assiette ovale
Teller oval
Plato oval
Piatto ovale

ANOP38 38 x 24.5 cm
15 x 9 2/3"

ANOP32 32 x 21 cm
12 3/5 x 8 1/4"

6

ANOP22 22 x 14 cm
8 2/3 x 5 5/9"

12



Breakfast cup
Tasse à déjeuner
Frühstückstasse
Taza desayuno
Tazza da colazione

ANCU36 9 cm - 36 cl
3 5/8" - 12 2/3 oz

12



Cappuccino cup
Tasse à cappuccino
Cappuccinotasse
Taza cappuccino
Tazza da cappuccino

ANCU28 8 cm - 28 cl
3 2/9" - 9 6/7 oz

12



Coffee/tea cup
Tasse à café/thé
Kaffee-/Teetasse
Taza a café/té
Tazza da caffè/tè

ANCU23 9 cm - 23 cl
3 5/8" - 8 oz

12



Coffee cup
Tasse à café
Kaffeetasse
Taza a café
Tazza da caffè

ANCU20 8 cm - 20 cl
3 2/9" - 7 oz

12



Saucer
Soucoupe
Untere
Platillo
Piattino

ANSA15 > ANCU36 / ANCU28 / ANCU23 / ANCU20

15.6 cm / 6 1/7"

12



Espresso cup
Tasse à espresso
Espressotasse
Taza a expreso
Tazza da espresso

ANCU08 6 cm - 8 cl
2 4/9" - 2 4/5 oz

12



Saucer
Soucoupe
Untere
Platillo
Piattino

ANSA13 > ANCU08

13 cm / 5 1/8"

12





Cream soup bowl
Tasse à bouillon
Suppentasse
Bol consomé
Scodella per zuppa

ANCS36 11 cm - 5.5 cm - 36 cl
4 1/3" - 2 1/6" - 12 2/3 oz

12



Sugar bowl & lid
Sucrier & couvercle
Zuckerdose & Deckel
Azucarero & tapa
Zuccheriera & coperchio

ANSU25 25 cl / 8 4/5 oz

6



Salt shaker
Salière
Salzstreuer
Salero
Sallera

ANSS01

6



Flower vase
Vase
Vase
Florero
Vaso

ANFV01 12 cm / 4 5/7"

6



Saucer
Soucoupe
Untere
Platillo
Piattino

ANSA17 > ANCS36 / ANGB35

17 cm / 6 3/5"

12



Jug
Carafe
Krug
Jarra
Caraffa

ANJU100 100 cl / 35 1/5 oz

ANJU60 60 cl / 21 1/9 oz

4



Pepper shaker
Poivrier
Pfefferstreuer
Pimentero
Pepiera

ANPS01

6



Candle holder
Bougeoir
Kerzenhalter
Porta velas
Portacandela

ANCH01 16 cm / 6 1/7"

4



Coffee pot & lid
Cafetière & couvercle
Kaffeekanne & Deckel
Cafetera & tapa
Caffettiera & coperchio

ANCP100 100 cl / 35 1/5 oz

4

ANCP35 35 cl / 12 1/3 oz

6



Gravy boat
Saucière
Sauciere
Salsera
Salsiera

ANGB35 35 cl / 12 1/3 oz

12

ANBGB15 15 cl / 5 2/7 oz

6



Teapot & lid
Théière & couvercle
Teekanne & Deckel
Tetera & tapa
Caffettiera & coperchio

ANTP40 40 cl / 14 oz

4



Egg cup
Coquetier
Eierbecher
Huevera
Portauovo

ANEG01 16 cm / 6 1/7"

12



Creamer
Crémier
Milchkännchen
Lechera
Bricco da latte

ANCR25 25 cl / 8 4/5 oz

6

ANCR15 15 cl / 5 2/7 oz

12

Pieces per box
Pièces par boîte
Stück pro Karton
Piezas por caja
Pezzi per scatola



En

With B.CONCEPT even the most diverse buffets can be presented harmoniously with four different heights.

Fr

B.CONCEPT permet de présenter les buffets les plus variés de façon toujours harmonieuse sur quatre hauteurs différentes.

De

B.CONCEPT gestattet die Präsentation von sehr vielfältigen Buffets auf harmonische Weise auf vier verschiedenen Höhen.

Es

B.CONCEPT permite presentar los más variados bufés de manera armoniosa en cuatro alturas diferentes.

It

La linea B.CONCEPT consente di presentare i buffet più vari in maniera armoniosa su quattro altezze differenti.



Platter

Plat
Platte
Fuente
Vassoio

LXBS51 51 x 30 cm
20 x 11 4/5"

LXBS30 30 x 26 cm
11 4/5 x 10 1/4"



Platter black

Plat noir
Platte schwarz
Fuente negro
Vassoio nero

LXBS51BK 51 x 30 cm
20 x 11 4/5"

LXBS30BK 30 x 26 cm
11 4/5 x 10 1/4"



Large wooden stand

Support bois grand modèle
Holzständer groß
Soporte de madera grande
Supporto in legno modello grande

WS51 51 x 30 cm
20 x 11 4/5"



Small wooden stand

Support bois petit modèle
Holzständer klein
Soporte de madera pequeño
Supporto in legno modello piccolo

WS30 30 x 26 cm
11 4/5 x 10 1/4"

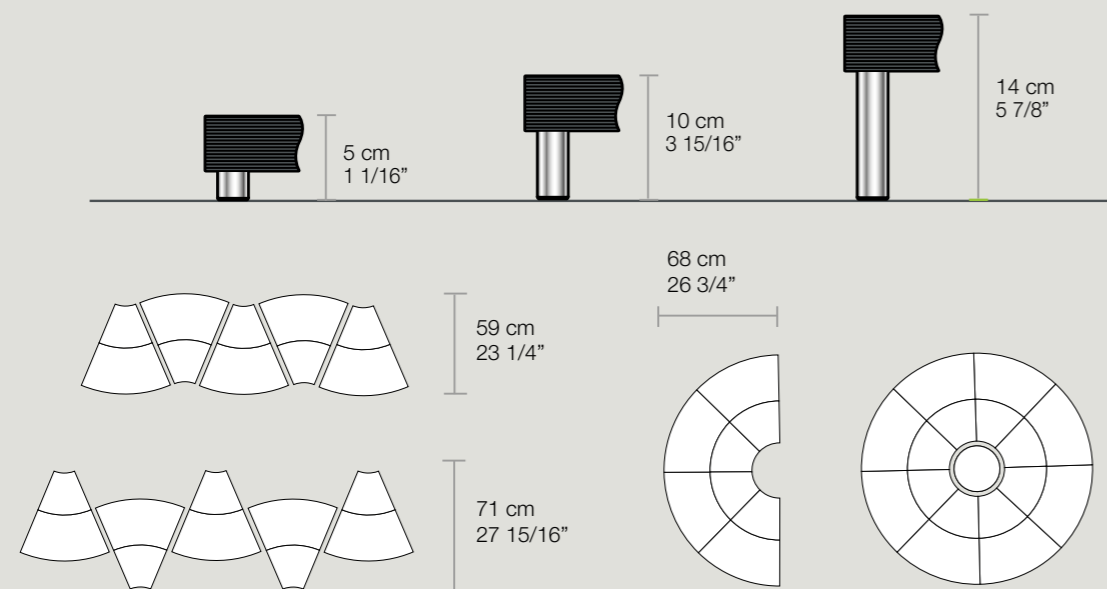

En
Support of varnished wood withstanding abrasion and mechanical shocks, available with 3 sets bases to screw on, 3 heights: 5 cm, 10 cm and 14 cm / 1 1/16", 3 15/16" and 5 7/8"

Fr
Support en bois vernis résistant à l'abrasion et aux chocs mécaniques, livré avec 3 jeux de pieds à visser, 3 hauteurs: 5 cm, 10 cm et 14 cm / 1 1/16", 3 15/16" et 5 7/8"

De
Träger aus lackiertem Holz, das Verschleißerscheinungen und mechanischen Stößen standhält, lieferbar mit 3 Fußsätzen zum Anschrauben, 3 Maße: 5 cm, 10 cm und 14 cm / 1 1/16", 3 15/16" und 5 7/8"

Es
Soporte de madera barnizada, resistente a la abrasión y a los choques mecánicos, se entrega con 3 juegos de patas enroscables, de 3 alturas: 5 cm, 10 cm y 14 cm / 1 1/16", 3 15/16" y 5 7/8"

It
Supporto legno verniciato, resistente all'abrasione e shock meccanico viene consegnato con 3 set di piedi, 3 altezze: 5 cm, 10 cm y 14 cm / 1 1/16", 3 15/16" y 5 7/8"



COLLECTION
BAHAMAS 2

SPECIALTY DINING

77

En
Sky blue, chilli red, lemon yellow and spring green, these bright colours of BAHAMAS 2 provide a dazzling range of items, for creating zingy harmonies.

Fr
Bleu ciel, rouge chilli, jaune citron, vert printemps, les couleurs vives de BAHAMAS 2 fournissent une palette éclatante de pièces permettant de créer des harmonies rafraîchissantes.

De
Himmelblau, Chilliroth, Zitronengelb, Frühlingsgrün – mit den lebhaften Farben der Kollektion Bahamas 2 schaffen Sie erfrischend neue harmonische Kombinationen.

Es
Azul cielo, rojo chile, amarillo limón, verde primavera: los colores vivos de BAHAMAS 2 ofrecen un brillante surtido de piezas que permiten crear refrescantes armonías.

It
Azzurro cielo, rosso peperoncino, giallo limone, verde pisello: i colori vivaci della linea BAHAMAS 2 offrono una lucente gamma di pezzi che consentono di creare armonie rinfrescanti.





Flat plate

Assiette plate
Teller flach
Plato llano
Piatto piano

30 cm / 11 4/5" **BAFP30D53**
 BAFP30D54
 BAFP30D56
 BAFP30D57

6
27 cm / 10 5/8" **BAFP27D53**
 BAFP27D54
 BAFP27D56
 BAFP27D57

24 cm / 9 4/9" **BAFP24D53**
 BAFP24D54
 BAFP24D56
 BAFP24D57

12
21 cm / 8 1/4" **BAFP21D53**
 BAFP21D54
 BAFP21D56
 BAFP21D57

15 cm / 6" **BAFP15D53**
 BAFP15D54
 BAFP15D56
 BAFP15D57

24



Deep plate

Assiette creuse
Teller tief
Plato hondo
Piatto fondo

26 cm / 10 1/4" **BADP26D53**
 BADP26D54
 BADP26D56
 BADP26D57

23 cm / 9" **BADP23D53**
 BADP23D54
 BADP23D56
 BADP23D57

12



Stackable salad bowl

Saladier empilable
Salatschale stapelbar
Ensaladera apilable
Insalatiera impilabile

16 cm - 7 cm - 60 cl **BASB16D53**
6 2/7" - 2 5/7" - 20 2/7 oz **BASB16D54**
 BASB16D56
 BASB16D57

12



Coffee/tea cup

Tasse à café/thé
Kaffee- /Teetasse
Taza a café/té
Tazza da té/caffè

23 cl / 7 7/8 oz **BACU23D53**
 BACU23D54
 BACU23D56
 BACU23D57

12

Saucer for coffee/tea cup

Soucoupe pour tasse à café/thé
Untere für Kaffee- /Teetasse
Platillo para taza a café/té
Piattino per tazza da té/caffè

15 cm / 6" **BASA15D53**
 BASA15D54
 BASA15D56
 BASA15D57

12



Espresso cup

Tasse à expresso
Espressotasse
Taza a expreso
Tazza da espresso

9 cl / 3 oz **BACU09D53**
 BACU09D54
 BACU09D56
 BACU09D57

12

Saucer for espresso cup

Soucoupe pour tasse à expresso
Untere für Espressotasse
Platillo para taza a expreso
Piattino per tazza da espresso

13 cm / 5 1/8" **BASA13D53**
 BASA13D54
 BASA13D56
 BASA13D57

12



Stackable mug

Chope empilable
Becher stapelbar
Mug apilable
Mug impilabile

30 cl / 10 1/7 oz **BASM30D53**
 BASM30D54
 BASM30D56
 BASM30D57

12

Pieces per box
Pièces par boîte
Stück pro Karton
Piezas por caja
Pezzi per scatola

En

The BANQUET collection consists of over 100 items for catering professionals and their daily needs. This collection is a perfect combination of functionality, durability and minimalist elegance.

Fr

La collection BANQUET se compose de plus de 100 pièces pour les professionnels et leurs besoins quotidiens. Cette collection associe à merveille fonctionnalité, robustesse et élégance minimaliste.

De

Die Kollektion BANQUET besteht aus über 100 Teilen und ist ideal für den professionellen Gebrauch und seine täglichen Anforderungen. Die Kollektion besticht durch hervorragende Funktionalität, Robustheit und minimalistische Eleganz.

Es

La colección BANQUET se compone de más de 100 piezas para satisfacer las necesidades diarias de los profesionales. Esta colección combina de maravilla funcionalidad, robustez y elegancia minimalista.

It

La collezione BANQUET è formata da oltre 100 pezzi dedicati ai professionisti e alle loro esigenze quotidiane. Questa collezione unisce con grande equilibrio funzionalità, robustezza ed eleganza minimalista.





Flat plate
Assiette plate
Teller flach
Plato llano
Piatto piano

BAFP31 31 cm / 12 1/5"
BAFP30 30 cm / 11 4/5"
6

BAFP29 29 cm / 11 3/7"
BAFP27 27 cm / 10 5/8"
BAFP25 25 cm / 9 5/6"
BAFP24 24 cm / 9 4/9"
BAFP23 23 cm / 9"

12

BAFP21 21 cm / 8 1/4"
BAFP20 20 cm / 7 7/8"
BAFP19 19 cm / 7 1/2"
BAFP17 17 cm / 6 2/3"
BAFP15 15 cm / 6"
BAFP13 13 cm / 5 1/8"

24



Pizza plate
Assiette à pizza
Pizzateller
Plato pizza
Piatto pizza

BAPP27 27 cm / 10 5/9"
12



Oval plate
Plat ovale
Platte oval
Fuente oval
Piatto ovale

BAOP45 45 x 33 cm / 17 5/7 x 13"
4

BAOP38 38 x 26 cm / 15 x 10 1/4"
BAOP32 32 x 22 cm / 12 3/5 x 8 2/3"

6

BAOP26 26 x 18.4 cm / 10 1/4 x 7 1/4"
BAOP22 22 x 15.5 cm / 8 2/3 x 6 1/9"

12



Saucer
Soucoupe
Untere
Platillo
Piattino

BAST01 > BACS30 / BACS02 / BACS01
17 cm / 6 2/3"
12



Stackable salad bowl
Saladier empilable
Salatschale stapelbar
Ensaladera apilable
Insalatiera impilabile

BASB21 21 cm - 7.5 cm - 118 cl
8 1/4" - 3" - 39 8/9 oz

BASB18 18 cm - 6.5 cm - 72 cl
7" - 2 5/9" - 24 1/3 oz

BASB16 16 cm - 7 cm - 60 cl
6 2/7" - 2 5/7" - 20 2/7 oz

BASB12 12 cm - 5.5 cm - 25 cl
4 5/7" - 2 1/8" - 8 4/9 oz

12



Salad bowl
Saladier
Salatschale
Ensaladera
Insalatiera

BASP31 31 cm - 13 cm - 590 cl
12 1/5" - 5 1/8" - 199 1/2 oz

BASP25 25 cm - 11 cm - 200 cl
9 5/6" - 4 1/3" - 67 3/5 oz

1

BASP20 20 cm - 8 cm - 105 cl
7 7/8" - 3 1/7" - 35 1/2 oz

BASP16 16 cm - 7.5 cm - 67 cl
6 2/7" - 3" - 22 2/3 oz

BASP14 14 cm - 7 cm - 50 cl
5 1/2" - 2 3/4" - 17 oz

BASP12 12 cm - 6 cm - 31 cl
4 5/7" - 2 1/3" - 10 1/2 oz

12



Deep plate
Assiette creuse
Teller tief
Plato hondo
Piatto fondo

BADP30 30 cm / 11 4/5"
6

BADP26 26 cm / 10 1/4"
BADP23 23 cm / 9"
BADP19 19 cm / 7 1/2"

12



Bowl
Bol
Schale
Bol
Coppetta

BABW14 14 cm - 6 cm - 63 cl
5 1/2" - 2 1/3" - 21 2/7 oz

BABW12 12 cm - 6 cm - 48 cl
4 5/7" - 2 1/3" - 16 2/9 oz

12

BACS01 10 cm - 6 cm - 30 cl
4" - 2 2/7" - 10 1/7 oz

6



Steak plate
Assiette à steak
Steakteller
Plato steak
Piatto per bistecca

BAOP30 30 x 25.5 cm
11 4/5 x 10"
6



Lugged soup bowl
Tasse bouillon
Suppentasse
Bol consomé
Scodella per zuppa

BACS02 10.5 cm - 6 cm - 30 cl
4 1/7" - 2 1/3" - 10 1/7 oz

12



Pizza plate
Assiette à pizza
Pizzateller
Plato pizza
Piatto pizza

BAPP33 33 cm / 13"
BAPP32 30.5 cm / 12"
6



Cream soup bowl, 2 handles
Tasse bouillon, 2 anses
Suppentasse, 2 Henkel
Bol consomé, 2 asas
Scodella per zuppa, 2 manici

BACS30 10.5 cm - 5.5 cm - 30 cl
4 1/7" - 2 1/5" - 10 1/7 oz

BACS18 8.5 cm - 5 cm - 18 cl
3 1/3" - 2" - 6 oz

6



Large mezza bowl
Grand bol mezza
Mezza Schale groß
Bol mezza grande
Coppetta mezza grande

BAMB17 17 cm - 4 cm - 36 cl
6 2/3" - 1 4/7" - 12 1/6 oz

12



Small mezza bowl
Petit bol mezza
Mezza Schale klein
Bol mezza pequeño
Coppetta mezza piccola

BAMB13 13 cm - 4 cm - 17 cl
5 1/8" - 1 4/7" - 5 3/4 oz

6



Noodle bowl
Bol à nouilles
Nudelschale
Noodle bol
Coppetta per pasta

BANB21 21 cm - 9 cm - 110 cl
8 1/4" - 3 1/2" - 37 1/5 oz

6



Arabic cup
Tasse arabisque
Tasse arabisch
Taza arábiga
Tazza arabe

BAAAC16 16 cl / 5 2/5 oz
BAAAC11 11 cl / 3 5/7 oz
BAAAC07 7 cl / 2 1/2 oz
BAAAC06 6 cl / 2 oz
BAAAC04 4 cl / 1 2/5 oz

12 ☰



Non stackable cup
Tasse non empilable
Tasse nicht stapelbar
Taza no apilable
Tazza non impilabile

BANC28 28 cl / 9 1/2 oz
BANC22 22 cl / 7 3/7 oz
BANC15 15 cl / 5 oz

12 ☰



Saucer
Soucoupe
Untere
Platillo
Piattino

BAST01 > BANC28
17 cm / 6 2/3"

12 ☰



Saucer
Soucoupe
Untere
Platillo
Piattino

BASA15 > BANC22 / BANC15
15 cm / 6"

12 ☰



Non stackable cup
Tasse non empilable
Tasse nicht stapelbar
Taza no apilable
Tazza non impilabile

BANC09 9 cl / 3 oz

12 ☰



Ristretto cup
Tasse ristretto
RistrettoTasse
Taza ristretto
Tazza ristretto

BANC07 7 cl / 2 3/8 oz

12 ☰



Saucer
Soucoupe
Untere
Platillo
Piattino

BASA13 > BANC09 / BANC07
13 cm / 5 1/8"

12 ☰



Stackable cup high
Tasse empilable haute
Tasse stapelbar hoch
Taza apilable alta
Tazza impilabile alta

BACU28 28 cl / 9 1/2 oz
BACU20 20 cl / 6 3/4 oz
BACU09 9 cl / 3 oz

12 ☰



Stackable cup
Tasse empilable
Tasse stapelbar
Taza apilable
Tazza impilabile

BACU23 23 cl / 7 7/9 oz
BACU18 18 cl / 6 oz

12 ☰



Saucer
Soucoupe
Untere
Platillo
Piattino

BAST01 > BACU28
17 cm / 6 2/3"

12 ☰



Saucer
Soucoupe
Untere
Platillo
Piattino

BASA15 > BACU23 / BACU20 / BACU18
15 cm / 6"

12 ☰



Saucer
Soucoupe
Untere
Platillo
Piattino

BASA13 > BACU09

13 cm / 5 1/8"

12 ☰



Mug
Chope
Becher
Mug
Mug

BAMG45 45 cl / 15 1/5 oz
BAMG36 36 cl / 12 1/6 oz

12 ☰



Saucer
Soucoupe
Untere
Platillo
Piattino

BAST01 > BAMG45
17 cm / 6 2/3"

12 ☰



Mug Flora
Chope Flora
Becher Flora
Mug Flora
Mug Flora

BAFMG36 36 cl / 12 1/6 oz

12 ☰

BAFMG30 30 cl / 10 1/7 oz

BAMG26 26 cl / 8 4/5 oz

6 ☰



Stackable Mug
Chope empilable
Becher stapelbar
Mug apilable
Mug impilabile

BASM30 30 cl / 10 1/7 oz

12 ☰



Mug Tulip
Chope Tulip
Becher Tulip
Mug Tulip
Mug impilabile

BATMG45 45 cl / 15 1/5 oz

BATMG30 30 cl / 10 5/9 oz

12 ☰



Mug
Chope
Becher
Mug
Mug

BAMG30 30 cl / 10 5/9 oz

12 ☰



Mug Lotus
Chope Lotus
Becher Lotus
Mug Lotus
Mug Lotus

BALMG30 30 cl / 10 5/9 oz

6 ☰



Stainer for mug Lotus
Filtre pour chope Lotus
Filter für Becher Lotus
Filtro para mug Lotus
Filtro per mug Lotus

BALMG30ST01 8 cm - 5.9 cm
3 1/7" - 2 1/3"

6 ☰



Lid for mug Lotus
Couvercle pour chope Lotus
Deckel für Becher Lotus
Tapa para mug Lotus
Coperchio per mug Lotus

BALMGD1 7.9 cm / 3 1/8"

6 ☰





Coffee pot & lid
Cafetière & couvercle
Kaffeekanne & Deckel
Cafetera & tapa
Caffettiera & coperchio
BACP70 70 cl / 23 2/3 oz
BACP35 35 cl / 11 5/6 oz
4

Lid for coffee pot
Couvercle pour cafetière
Deckel für Kaffeekanne
Tapa para cafetera
Coperchio per caffettiera
BACPLD2 > BACP70
BACPLD1 > BACP35
12



Teapot & lid
Théière & couvercle
Teekanne & Deckel
Tetera & tapa
Teiera & coperchio
BATP100 100 cl / 33 4/5 oz
BATP80 80 cl / 27 oz
4
BATP40 40 cl / 13 1/2 oz
4

Lid for teapot
Couvercle pour théière
Deckel für Teekanne
Tapa para tetera
Coperchio per teiera
BATPLD2 > BATP80
12
BATPLD1 > BATP40
12



Creamer
Crémier
Milchkännchen
Lechera
Bricco da latte
BACR35 35 cl / 11 5/6 oz
BACR25 25 cl / 8 4/9 oz
BACR15 15 cl / 5 oz
6
BACR05 5 cl / 1 11/16 oz
24



Gravy boat
Saucière
Sauciere
Salsera
Salsiera
BAGB35 35 cl / 11 5/6 oz
4
BAGB15 15 cl / 5 oz
6



Saucer
Soucoupe
Untere
Platillo
Piattino
BASA15 > BAGB35
15 cm / 5 7/8"
BASA13 > BAGB15
13 cm / 5 1/8"
12



Stackable butter ramekin
Ramequin beurre empilable
Butterschälchen stapelbar
Platillo para mantequilla apilable
Coppetta da burro impilabile
BABR02 8 cm - 3.5 cm - 10 cl
3 1/7" - 1 3/8" - 3 3/8 oz
12



Stackable butter ramekin
Ramequin beurre empilable
Butterschälchen stapelbar
Platillo para mantequilla apilable
Coppetta da burro impilabile
BABR03 7 cm - 3 cm - 6 cl
2 3/4" - 1 1/16" - 2 oz
12



Butter ramekin
Ramequin beurre
Butterschälchen
Platillo para mantequilla
Coppetta da burro
BABR01 6.7 cm - 6 cl / 2 2/3" - 2 oz
BABR05 5 cm / 2"
12



Butter dish
Assiette à beurre
Butterteller
Plato mantequilla
Piatto da burro
BABD11 11 x 8 cm / 4 1/3 x 3 1/7"
12



Continental sauce dish
Plat à sauce continental
Saucenschale continental
Salsera continental
Salsiera continentale
BACD09 9 x 7 cm / 3 1/2 x 2 3/4"
12



Pepper shaker
Poivrier
Pfefferstreuer
Pimentero
Pepiera
BAPS01
6



Salt shaker
Salière
Salzstreuer
Salero
Saliera
BASS01
6



Sumek shaker
Salière Sumek
Sumekstreuer
Salero Sumek
Saliera Sumek
BASM01
6



Egg cup
Coquetier
Eierbecher
Huevera
Portauovo
BAEG01
6



Sugar bowl & lid
Sucrier & couvercle
Zuckerdose & Deckel
Azucarero & tapa
Zuccheriera & coperchio
BASU27 27 cl / 9 1/8 oz
6

Lid for sugar bowl
Couvercle pour sucrier
Deckel für Zuckerdose
Tapa para azucarero
Coperchio per zuccheriera
BASULD
12



Sliding sugar pack holder
Sucrier oblique
pour dosettes
Zuckertütenschale schräg
Azucarero sobres obliqua
Portabustine da zucchero
obliquo
BASH03 11 x 6 cm - 5 cm - 10 cl
4 1/3 x 2 1/3" - 2" - 3 3/8 oz
6



Sugar pack holder
Sucrier à sachets
Zuckertütenschale
Azucarero sobres
Portabustine da zucchero
BASH01 11 x 7 cm - 4 cm - 20 cl
4 1/3 x 2 3/4" - 1 4/7" -
6 3/4 oz
6





Round sugar pack holder
Sucrier rond à sachets
Zuckertütenschale rund
Azucarero sobres redondo
Contenitore rotondo per pacco di zucchero

BASH02 8.5 cm - 23 cl
3 1/3" - 7 7/9 oz

12



Cigar ashtray
Cendrier à cigares
Zigarrenascher
Cenicero a puros
Portacenere per sigari

BACA01 21 x 16 cm
8 1/4 x 6 2/7"

2



Rectangular ashtray
Cendrier rectangulaire
Ascher rechteckig
Cenicero rectangular
Portacenere rettangolare

BAAT03

6



Shell dish
Recipient coquillage
Schale in Muschelform
Concha plato
Coppetta conchiglia

BASO01 14 x 12.5 cm
5 3/7 x 5"

12



Toothpick holder
Conteneur cure-dents
Zahnstocherhalter
Palillero
Portastecchini

BATH01 7 cl / 2 3/8 oz

12



Ashtray
Cendrier
Ascher
Cenicero
Portacenere

BAAT01 11 cm / 4 1/3"

12



Windproof square ashtray
Cendrier anti-vent
Ascher windgeschützt
Cenicero contravientos
Portacenere - protetto del vento

BAAT11 11.5 x 11.5 cm
4 1/2 x 4 1/2"

12



Oval shell dish
Coupelle coquillage
Schale in Muschelform
Concha plato
Coppetta conchiglia

BASO02 13 x 8.5 cm
5" x 3 2/5"

12



Menu label holder
Porte menu
Menühalter
Soporte menú
Portamenu

BAMH01 10.5 cm - 7.5 cm
4 1/7" - 3"

12



Napkin holder
Porte serviette
Serviettenhalter
Servilletero
Portatovaglioli

BATW01 15 x 11 cm
6 x 4 1/3"

BATW02 17 x 8 cm
6 3/5 x 3 1/7"

12



Cigar ashtray rectangular
Cendrier à cigares rectangulaire
Zigarrenascher rechteckig
Cenicero del cigarro rectangular
Portacenere rettangolare per sigari

BACA02

2



Olive dish
Plat à olives
Oliven Teller
Oliva plato
Piatto da olive

BAOL01 11.5 x 9 cm
4 1/2 x 3 1/2"

12



Napkin holder
Porte serviette
Serviettenhalter
Servilletero
Portatovaglioli

BANH01 10.5 cm - 7.5 cm
4 1/7" - 3"

12



Candle holder
Bougeoir
Kerzenhalter
Porta velas
Portacandela

BACH01

12



Napkin ring
Anneau à serviette
Serviettenring
Anillo servilletero
Portatovagliolo

BANR01 6 cm / 2 1/3"

12



Ashtray
Cendrier
Ascher
Cenicero
Portacenere

BAAT02

12



Flower vase
Vase
Vase
Florero
Vaso

BAFV01 12 cm / 4 5/7"

6



12 Pieces per box
Pièces par boîte
Stück pro Karton
Piezas por caja
Pezzi per scatola

12 Extra time for deliveries
Délai supplémentaire
Zusätzliche Lieferzeit
Período de abastecimiento adicional
Termine di consegna supplementare

En

The BUFFET collection combines design with unfailing toughness. The BUFFET GN range includes all the sizes of hotplates, display cases and refrigerated display shelves in line with the GASTRONORM standards.

Fr

La collection BUFFET réunit design et solidité à toutes épreuves. BUFFET GN possède toutes les tailles de chauffe-plats, vitrines, présentoirs réfrigérés et fours de cuisson à la norme GASTRONORM.

De

In der Kollektion BUFFET verschmelzen attraktives Design und höchste, dauerhafte Robustheit. BUFFET GN verfügt über sämtliche Größen der GASTRONORM-Norm für den Einsatz in Warmhalteplatten, (Kühl-)Vitrinen und Öfen.

Es

La colección BUFFET reúne el diseño y la solidez a toda prueba. BUFFET GN ofrece calentaplatos, vitrinas, expositores refrigerados y hornos de todos los tamaños conforme a la norma GASTRONORM.

It

La collezione BUFFET fonde design e solidità assoluta. La linea BUFFET GN presenta le forme e le dimensioni conformi alla norma GASTRONORM relativa all'utilizzo su scaldavivande, vetrine, espositori refrigerati e forni di cottura.





Asymmetric bowl
Bol asymétrique
Schale asymmetrisch
Bol asimétrico
Coppetta asimmetrica

BUBA29 29 cm - 14 cm - 160 cl
11 3/7" - 5 1/2" - 54 oz



BUBA22 22 cm - 9 cm - 65 cl
8 2/3" - 3 1/2" - 22 oz



Soup tureen & lid
Soupière & couvercle
Suppenterrine & Deckel
Sopera & tapa
Zuppiera & coperchio

BUCD27 27 cm - 18 cm - 345 cl
10 5/7" - 7" - 121 3/7 oz

BUCD23 24 cm - 16 cm - 217 cl
9 1/3" - 6 3/8" - 76 3/8 oz

BUCD21 21 cm - 14 cm - 137 cl
8" - 5 1/2" - 48 2/9 oz



BUCD15 15 cm - 58 cl
5 14/16" - 19 3/5 oz



Lid for soup tureen
Couvercle pour soupière
Deckel für Suppenterrine
Tapa para sopra
Coperchio per Zuppiera

BULD27 > BUCD27
27.5 cm - 8.5 cm
10 4/5" - 3 1/3"



BULD23 > BUCD23
23.5 cm - 8 cm
9 2/7" - 3 1/7"



BULD21 > BUCD21
20.5 cm - 7 cm
8" - 2 4/5"



BULD15 > BUCD15
15.5 cm - 5 cm
6" - 2"



Soup tureen & lid
Soupière & couvercle
Suppenterrine & Deckel
Sopera & tapa
Zuppiera & coperchio

BUST27 27.5 cm - 18 cm - 350 cl
10 5/6" - 7" - 123 1/5 oz

BUST15 15.5 cm - 10.5 cm - 40 cl
6" - 4" - 14 oz



Oval casserole & lid
Casserole ovale & couvercle
Ovaler Topf & Deckel
Cacerola oval & tapa
Casseruola ovale & coperchio

BUOC35 35 cm - 22 cm - 245 cl
13 5/6" - 8 4/7" - 86 2/9 oz



Oval dish
Plat ovale
Platte ovale
Fuente oval
Vassoio ovale

BUOD37 37 x 26 x 6 cm
14 4/7 x 10 1/4 x 2 2/7"



BUOD30 30 x 20 x 6 cm
11 4/5 x 7 7/8 x 2 1/3"



BUOD28 28 x 19 x 6 cm
11 x 7 1/2 x 2 1/3"



BUOD25 25 x 18 x 5 cm
9 5/6 x 7 x 2"



Coupe bowl
Bol coupe
Schale coupe
Plato coupe
Coppetta senza falda

BUBC46 46 cm - 4 cm - 575 cl
18 1/9" - 1 4/7" - 194 2/5 oz

BUBC36 36 cm - 4 cm - 360 cl
14 1/6" - 1 4/7" - 121 5/7 oz



Square bowl
Bol carré
Schale quadratisch
Bol cuadrado
Coppetta quadrata

BUBS25 25 cm - 416 cl
9 5/6" - 140 5/8 oz

BUBS23 23 cm - 300 cl
9 1/7" - 101 oz

BUBS21 21 cm - 200 cl
8" - 68 oz



Oval dish
Plat ovale
Platte ovale
Fuente oval
Vassoio ovale

BUOP56 56 x 21 x 5.5 cm - 220 cl
22 x 8 1/4 x 2 1/6" - 74 3/8 oz



Oval dish
Plat ovale
Platte ovale
Fuente oval
Vassoio ovale

BUOV40 40 x 23 x 4 cm - 154 cl
15 3/4 x 9 x 1 4/7" - 52 oz

BUOV36 36 x 22 x 5 cm - 136 cl
14 1/6 x 8 2/3 x 2" - 46 oz



BUOV30 29.5 x 17.5 x 5.5 cm - 100 cl
11 1/2 x 6 8/9 x 2 1/6" - 35 1/5 oz

BUOV24 24 x 14.3 x 4.2 cm - 54 cl
9 4/9 x 5 5/8 x 1 2/3" - 18 1/4 oz





Rectangular pan
Plat rectangulaire
Platte rechteckig
Fuente rectangular
Piatto rettangolare

BURP44 44 x 36 x 6 cm - 500 cl
17 1/3 x 14 1/6 x 2 1/3" - 169 oz
BURP37 37 x 30 x 6 cm - 347 cl
14 4/7 x 11 4/5 x 2 1/3" - 117 1/3 oz



BURP30 30 x 24 x 6.5 cm - 212 cl
11 4/5 x 9 3/8 x 2 1/2" - 71 2/3 oz



Rectangular tray
Plat rectangulaire
Platte rechteckig
Fuente rectangular
Vassoio rettangolare

BURT52 52 x 24 cm / 20 1/2 x 9 4/9"
BURT41 41 x 30 cm / 16 1/7 x 11 4/5"
6



Salad bowl xxl
Saladier xxl
Salatschale xxl
Ensaladera xxl
Insalatiera xxl

BUSB31 31 cm - 17 cm - 600 cl
12 1/5" - 6 2/3" - 202 5/6 oz



Square dish
Ravier carré
Schale quadratisch
Rabanera cuadrada
Coppetta quadrata

BUSD28 28 x 28 x 6 cm - 243 cl
11 x 11 x 2 1/3" - 82 1/7 oz



BUSD22 22.5 x 22.5 x 4.5 cm - 100 cl
8 6/7 x 8 6/7 x 1 7/9" - 33 4/5 oz



Tray with possible combinations
Plat avec possibilité de combinaisons
Schale mit Kombinationsmöglichkeiten
Fuente y posibilidad de combinación
Vassoio con combinazione possibile

LXDB18 18 x 20 x 6 cm
7 x 7 7/8 x 2 1/3"



Tray with possible combinations
Plat avec possibilité de combinaisons
Schale mit Kombinationsmöglichkeiten
Fuente y posibilidad de combinación
Vassoio con combinazione possibile

LXBW18 18 x 20 x 6 cm
7 x 7 7/8 x 2 1/3"



Tray with possible combinations
Plat avec possibilité de combinaisons
Schale mit Kombinationsmöglichkeiten
Fuente y posibilidad de combinación
Vassoio con combinazione possibile

LXRB27 27 x 20 x 6 cm
10 5/8 x 7 7/8 x 2 1/3"



Oblong insert
Plat oblong
Schale länglich
Plato oblongo
Piatto oblungo

BUGO40 40 x 27 x 5 cm - 300 cl
15 5/6 x 10 5/7 x 2" - 105 3/5 oz

BUGO36 36 cm x 23.7 cm x 5 cm - 250 cl
14 1/7 x 9 1/3 x 2" - 88 oz

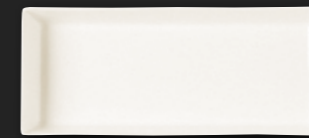

Stackable rectangular long dish
Plat rectangulaire long empilable
Schale rechteckig lang stapelbar
Plato rectangular largo apilable
Coppetta lunga rettangolare impilabile

LXRB47 47 x 20 x 6 cm
18 1/2 x 7 7/8 x 2 1/3"



Wine cooler
Seau a vin
Weinkühler
Vinoteca
Secchiello per il vino

BUWB25 25 cm - 20 cm - 400 cl
9 4/5" - 7 7/8" - 140 7/9 oz



Rectangular tray, 2 indents
Plat rectangulaire,
2 empreintes
Platte rechteckig,
2 Ringe
Fuente rectangular,
2 estanques
Vassoio rettangolare,
2 inserti

BUGR35 35 x 30 x 6 cm - 430 cl
13 5/7 x 12 x 2 2/5" - 151 1/3 oz

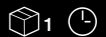

Pieces per box
Pièces par boîte
Stück pro Karton
Piezas por caja
Pezzi per scatola

Extra time for deliveries
Délai supplémentaire
Zusätzliche Lieferzeit
Período de abastecimiento adicional
Termine di consegna supplementare

1/1



Gastronorm pan
Plat Gastronorm
Schale Gastronorm
Fuente Gastronorm
Contentitore Gastronorm

BUGN1.1 53 x 32.5 x 6.5 cm - 730 cl
20 6/7 x 12 4/5 x 2 5/9" -
246 4/5 oz



1/3

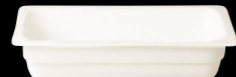

Gastronorm pan
Plat Gastronorm
Schale Gastronorm
Fuente Gastronorm
Contentitore Gastronorm

BUGN1.3 32.5 x 17.6 x 6.5 cm - 200 cl
12 4/5 x 7 x 2 5/9" - 67 3/5 oz



2/4



Gastronorm pan
Plat Gastronorm
Schale Gastronorm
Fuente Gastronorm
Contentitore Gastronorm

BUGN2.4 53 x 16.2 x 6.5 cm - 260 cl
20 6/7 x 6 3/8 x 2 5/9" - 87 8/9 oz

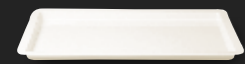

Gastronorm pan
Plat Gastronorm
Schale Gastronorm
Fuente Gastronorm
Contentitore Gastronorm

BUGN1.1F 53 x 32.5 x 2 cm - 220 cl
20 6/7 x 12 4/5 x 4/5" -
74 3/8 oz



Gastronorm pan
Plat Gastronorm
Schale Gastronorm
Fuente Gastronorm
Contentitore Gastronorm

BUGN1.3F 32.5 x 17.6 x 2 cm - 79 cl
12 4/5 x 7 x 4/5" - 26 5/7 oz



Gastronorm pan
Plat Gastronorm
Schale Gastronorm
Fuente Gastronorm
Contentitore Gastronorm

BUGN2.4F 53 x 16.2 x 2 cm - 125 cl
20 6/7 x 6 3/8 x 4/5" - 42 1/4 oz



Round gastronorm pan
Plat Gastronorm rond
Schale Gastronorm rund
Fuente Gastronorm
redondo
Contentitore Gastronorm
rotondo

BUGN39 39 x 6.2 cm - 433 cl
15 1/3 x 2 4/9" - 146 3/8 oz



**Round divided
Gastronorm pan**
Plat Gastronorm
rond divisé
Schale Gastronorm
rund geteilt
Fuente Gastronorm
redondo dividido
Contentitore Gastronorm
rotondo con divisione

BUGN39D 39 x 6.2 cm - 400 cl
15 1/3 x 2 4/9" - 135 2/9 oz



1/2



Gastronorm pan
Plat Gastronorm
Schale Gastronorm
Fuente Gastronorm
Contentitore Gastronorm

BUGN1.2 32.5 x 26.5 x 6.5 cm - 330 cl
12 4/5 x 10 3/7 x 2 5/9" -
111 5/9 oz



2/3



Gastronorm pan
Plat Gastronorm
Schale Gastronorm
Fuente Gastronorm
Contentitore Gastronorm

BUGN2.3 32.5 x 35.4 x 6.5 cm - 478 cl
12 4/5 x 14 x 2 5/9" - 161 3/5 oz



Gastronorm pan
Plat Gastronorm
Schale Gastronorm
Fuente Gastronorm
Contentitore Gastronorm

BUGN1.2F 32.5 x 26.5 x 2 cm - 130 cl
12 4/5 x 10 3/7 x 4/5" - 44 oz

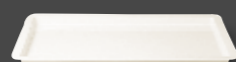

Gastronorm pan
Plat Gastronorm
Schale Gastronorm
Fuente Gastronorm
Contentitore Gastronorm

BUGN2.3F 32.5 x 35.4 x 2 cm - 188 cl
12 4/5 x 14 x 4/5" - 63 5/9 oz



Half-moon gastronorm pan
Plat Gastronorm demi-lune
Schale Gastronorm Halbmond
Fuente Gastronorm media-luna
Contentitore Gastronorm mezzaluna

BUGN20 39 x 19.5 x 6.5 cm - 191 cl
15 1/3 x 7 2/3 x 2 5/9" - 64 4/7 oz



Half-moon gastronorm pan
Plat Gastronorm demi-lune
Schale Gastronorm Halbmond
Fuente Gastronorm media-luna
Contentitore Gastronorm mezzaluna

BUGN20F 39 x 19.5 x 2 cm - 95 cl
15 1/3 x 7 2/3 x 4/5" - 32 1/9 oz



Pieces per box
Pièces par boîte
Stück pro Karton
Piezas por caja
Pezzi per scatola

Extra time for deliveries
Délai supplémentaire
Zusätzliche Lieferzeit
Período de abastecimiento adicional
Termine di consegna supplementare



COLLECTION
CLASSIC GOURMET

CASUAL DINING

99

En

With its range of square, round or rectangular shapes, CLASSIC GOURMET's easy handling and extreme toughness are a must for any professional.

Fr

Grâce à l'éventail de ses formes carrées, rondes ou rectangulaires, CLASSIC GOURMET offre une facilité de manipulation et une résistance extrême qui séduit les professionnels.

De

Dank des großen Spektrums an quadratischen, runden und rechteckigen Formen bietet die Kollektion CLASSIC GOURMET eine einfache Handhabung und eine extreme Langlebigkeit, die alle Profis aus der Gastronomie überzeugt.

Es

Gracias a la amplia variedad de sus formas cuadradas, redondas o rectangulares, CLASSIC GOURMET ofrece una facilidad de manipulación y una resistencia extrema que seduce a los profesionales.

It

Grazie alla sua vasta gamma di forme quadrate, rotonde e rettangolari, la facilità di utilizzo e la resistenza estrema, la linea CLASSIC GOURMET sa sedurre i professionisti.



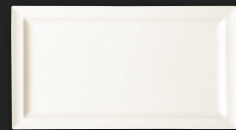

Rectangular flat plate
Assiette plate rectangulaire
Teller flach rechteckig
Plato llano rectangular
Piatto piano rettangolare

CLRP38 38 x 21 cm
15 x 8 1/4"

CLRP33 33 x 23 cm
13 x 9"



CLRP29 29 x 12 cm
11 3/7 x 4 5/7"

CLRP26 26 x 8 cm
10 1/4 x 3 1/7"

CLRP23 23 x 7 cm
9 x 2 3/4"

CLRP21 21 x 7 cm
8 1/4 x 2 3/4"



**Rectangular tray,
3 compartments**
Plat rectangulaire,
3 compartiments
Platte rechteckig,
3 Flächen
Bandeja rectangular,
3 compartimentos
Vassoio rettangolare,
3 compartimenti

CLRP38IN3 39 x 21 cm
15 2/7 x 8 2/5"

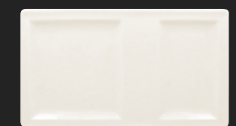

**Rectangular tray,
2 compartments**
Plat rectangulaire,
2 compartiments
Platte rechteckig,
2 Flächen
Bandeja rectangular,
2 compartimentos
Vassoio rettangolare,
2 compartimenti

NEW

CLRP37IN2 37 x 21 cm
14 4/7 x 8 1/4"



Square flat plate
Assiette plate carrée
Teller flach quadratisch
Plato llano cuadrado
Piatto piano quadrato

CLSP30 30 cm / 11 4/5"



CLSP27 27 cm / 10 5/8"

CLSP24 24 cm / 9 4/9"



Round flat plate
Assiette plate ronde
Teller flach rund
Plato llano redondo
Piatto piano rotondo

CLFP33 33 cm / 13"

CLFP31 31 cm / 12 1/5"



CLFP29 29 cm / 11 3/7"

CLFP27 27 cm / 10 5/8"

CLFP24 24 cm / 9 4/9"



CLFP21 21 cm / 8 1/4"

CLFP19 19 cm / 7 1/2"

CLFP17 17 cm / 6 2/3"

CLFP15 15 cm / 6"



Round deep plate
Assiette creuse ronde
Teller tief rund
Plato hondo redondo
Piatto fondo rotondo

CLDP30 30 cm / 11 4/5"



CLDP26 26 cm / 10 1/4"

CLDP24 24 cm / 9 4/9"

CLDP19 19 cm / 7 5/9"



Extra deep round plate
Assiette extra creuse ronde
Teller extra tief rund
Plato extra hondo redondo
Piatto extra fondo rotondo

CLXD26 26 cm / 10 1/4"

CLXD23 23 cm / 9"



Square salad bowl
Saladier carré
Salatschale quadratisch
Ensaladera cuadrado
Insalatiera quadrata

CLSB21 21 cm - 4.5 cm - 65 dl
8 1/4" - 1 7/9" - 22 oz



CLSB18 18 cm - 4.5 cm - 45 dl
7" - 1 7/9" - 15 2/9 oz

CLSB16 16 cm - 4.5 cm - 40 dl
6 2/7" - 1 7/9" - 13 1/2 oz

CLSB14 14 cm - 4.5 cm - 32 dl
5 1/2" - 1 7/9" - 10 5/9 oz

CLSB12 12 cm - 4.5 cm - 20 dl
4 5/7" - 1 7/9" - 6 3/4 oz



Cream soup bowl with 2 handles
Tasse bouillon avec 2 anses
Suppentasse mit 2 Henkel
Bol consommé con 2 asas
Scodella per zuppa con 2 manici

CLCS30 10.5 cm - 6 cm - 30 dl
4 1/7" - 2 1/3" - 10 1/7 oz



Non stackable cup
Tasse non empilable
Tasse nicht stapelbar
Taza no apilable
Tazza non impilabile

CLCU28 28 cl / 9 1/2 oz

CLCU23 23 cl / 7 7/9 oz

CLCU20 20 cl / 6 3/4 oz

CLCU09 9 cl / 3 oz



Stackable cup
Tasse empilable
Tasse stapelbar
Taza apilable
Tazza impilabile

CLSC23 23 cl / 7 7/9 oz

CLSC20 20 cl / 6 3/4 oz

CLSC09 9 cl / 3 oz



Saucer for cup
Soucoupe pour tasse
Untere für Tasse
Platillo para taza
Piattino per tazza

CLSA17 > CLCU28 / CLCS30
17 cm / 6 2/3"

**CLSA15 > CLSC(CU)23 /
CLSC(CU)20**

15 cm / 6"

CLSA13 > CLSC09 / CLCU09
13 cm / 5 1/8"



Coffee pot & lid
Cafetière & couvercle
Kaffeekanne & Deckel
Cafetera & tapa
Caffettiera & coperchio

CLCP35 35 cl / 11 5/6 oz



Lid for coffee pot
Couvercle pour cafetière
Deckel für Kaffeekanne
Tapa para cafetera

CLCPLD1



COLLECTION
CLASSIC GOURMET

CASUAL DINING

103



Teapot & lid
Théière & couvercle
Teekanne & Deckel
Tetera & tapa
Teiera & coperchio

CLTP40 40 cl / 13 1/2 oz



4

Lid for teapot
Couvercle pour théière
Deckel für Teekanne
Tapa para tetera
Coperchio per teiera

CLTP40LD



12



Salt shaker
Salière
Salzstreuer
Salero
Saliera

CLSS01



6



Pepper shaker
Poivrier
Pfefferstreuer
Pimentero
Pepiera

CLPS01



6



Creamer
Crémier
Milchkännchen
Lechera
Bricco da latte

CLCR25 25 cl / 8 4/9 oz

CLCR15 15 cl / 5 oz



12



Egg cup
Coquetier
Eierbecher
Huevera
Portauovo

CLEG01



6



Sugar bowl & lid
Sucrier & couvercle
Zuckerdose & Deckel
Azucarero & tapa
Zuccheriera & coperchio

CLSU27 27 cl / 9 1/8 oz



6

Lid for sugar bowl
Couvercle pour sucrier
Deckel für Zuckerdose
Tapa para azucarero
Coperchio per zuccheriera

CLSULD



12



 Pieces per box
Pièces par boîte
Stück pro Karton
Piezas por caja
Pezzi per scatola



COLLECTION
FINE DINE

ELEGANT DINING

105

En

FINE DINE's ultra-sleek line gives it a timeless elegance. Chefs love the vast array of items which make up this collection for desserts, breakfasts and starters.

Fr

Les lignes très épurées de FINE DINE lui confèrent une élégance intemporelle. Les chefs apprécient la multitude de pièces formant la collection pour les desserts, petits-déjeuners et entrées.

De

Die schlichten Linien verleihen der Kollektion FINE DINE eine zeitlose Eleganz. Die Küchenchefs schätzen die Vielzahl an Teilen der Kollektion für Desserts, Frühstück und Vorspeisen.

Es

Las líneas depuradas de FINE DINE le confieren una elegancia atemporal. Los chefs aprecian la multitud de piezas que forman la colección para postres, desayunos y entrantes.

It

La collezione FINE DINE presenta delle linee essenziali che le conferiscono un'eleganza senza tempo. Gli chef apprezzano la miriade di pezzi che formano la collezione per i dessert, le colazioni e gli antipasti.





Flat plate
Assiette plate
Teller flach
Plato llano
Piatto piano

FDPP33 33 cm / 13"
FDPP31 31 cm / 12 1/5"
6
FDPP29 29 cm / 11 3/7"
FDPP27 27 cm / 10 5/8"
FDPP25 25 cm / 9 5/6"
FDPP22 22 cm / 8 2/3"
12
FDPP16 16 cm / 6 2/7"
24



Cover for gourmet deep plate
Cloche pour assiette creuse gourmet
Cloche für Gourmetteller tief
Campana para gourmet plato hondo
Coperchio per piatto piano gourmet

FDCL02 > FDGD29
15.5 cm / 6 1/9"
FDCL01 > FDGD26
13.6 cm / 5 1/3"
6



Oval platter
Plat ovale
Platte oval
Fuente oval
Piatto ovale

FDOP30 30 x 8 cm
11 4/5 x 3 1/7"
12



Oval platter
Plat ovale
Platte oval
Fuente oval
Piatto ovale

FDOP46 46 x 22 cm
18 1/9 x 8 2/3"
FDOP40 40 x 19 cm
15 3/4 x 7 1/2"
12



Oval platter
Plat ovale
Platte oval
Fuente oval
Piatto ovale

FDOP36 36 x 27 cm
14 1/6 x 10 5/8"
FDOP34 34 x 25.5 cm
13 2/5 x 10"
6



Deep plate
Assiette creuse
Teller tief
Plato hondo
Piatto fondo

FDDP31 31 cm / 12 1/5"
6
FDDP23 23 cm / 9"
12



Gourmet flat plate
Assiette plate gourmet
Gourmetteller flach
Plato llano gourmet

FDGF29 29 cm / 11 3/7"
12



Gourmet deep plate
Assiette creuse gourmet
Gourmetteller tief
Plato hondo Gourmet
Piatto fondo gourmet

FDGD29 29 cm / 11 3/7"
FDGD26 26 cm / 10 1/4"
6



Oval salad bowl
Saladier ovale
Salatschale oval
Ensaladera oval
Insalatiera ovale

FDBO27 27 x 19 cm - 6 cm
10 5/8 x 7 1/2" - 2 1/3"
FDBO24 24 x 16 cm - 8 cm
9 4/9 x 6 2/7" - 3 1/7"
FDBO16 16 x 11 cm - 5 cm
6 2/7 x 4 1/3" - 2"
6



Round salad bowl
Saladier rond
Salatschale rund
Ensaladera redondo
Insalatiera rotonda

FDBS23 23 cm - 140 cl
9" - 47 1/3 oz
12



Round bowl
Bol rond
Schale rund
Bol redondo
Coppetta rotonda

FDBI14 14 cm - 6.5 cm - 45 cl
5 1/2" - 2 2/3" - 15 1/5 oz
FDBI12 12 cm - 6 cm - 28 cl
4 5/7" - 2 1/3" - 9 1/2 oz
FDBI11 11 cm - 5 cm - 22 cl
4 1/3" - 2" - 7 3/7 oz
FDBI08 8 cm - 4 cm - 11 cl
3 1/7" - 1 4/7" - 3 5/7 oz
12



Lid for bowl
Couvercle pour bol
Deckel für Schale
Tapa para bol
Coperchio per coppetta

FDBI14LD > FDBI14 14.2 cm - 4.5 cm
5 3/5" - 1 7/9"
FDBI11LD > FDBI11 11.6 cm - 3.6 cm
4 4/7" - 1 3/7"

12



Extra thick round bowl
Bol rond extra épais
Schale rund extra dick
Bol redondo extra grueso
Coppetta rotonda alto spessore

FDBI14M 14 cm - 6.5 cm - 45 cl
5 1/2" - 2 3/5" - 15 5/6 oz

12



Cream soup bowl with 2 handles
Tasse à bouillon avec 2 anses
Suppentasse mit 2 Henkel
Bol consommé con 2 asas
Scodella per zuppa con 2 manici

FDCS35 11 cm - 6 cm - 35 cl
4 1/3" - 2 1/3" - 11 5/6 oz

6



Cream soup bowl without handle
Tasse à bouillon sans anse
Suppentasse ohne Henkel
Bol consommé sin asa
Scodella per zuppa senza manici

FDCS01 11 cm - 6 cm - 35 cl
4 2/5" - 2 1/3" - 15 5/6 oz

6



Saucer for cream soup bowl
Soucoupe pour tasse à bouillon
Untere für Suppentasse
Platillo para bol consommé
Piattino per scodella per zuppa

FDSA19 > FDCS35 / FDCS01
19 cm / 7 1/2"

12





Breakfast cup
Tasse à déjeuner
Frühstückstasse
Taza de desayuno
Tazza da colazione
FDCU30 30 cl / 10 1/7 oz
12



Saucer for espresso cup
Soucoupe pour tasse à espresso
Untere für Espressotasse
Platillo para taza a expreso
Piattino per tazza da espresso
FDSA13 > FDCU09 13 cm / 5 1/8"
12



Saucer for breakfast cup
Soucoupe pour tasse à déjeuner
Untere für Frühstückstasse
Platillo para taza de desayuno
Piattino per tazza da colazione
FDSA17 > FDCU30 17 cm / 6 2/3"
12



Square saucer for espresso cup
Soucoupe carrée pour tasse à espresso
Untere quadratisch für Espressotasse
Platillo cuadrado para taza expreso
Piattino quadrato per Tazza da espresso
OPSA12 > FDCU09 13 cm / 5"
12



Tea/coffee cup
Tasse à thé/café
Tee- /Kaffeetasse
Taza a té/café
Tazza da tè/caffè
FDCU25 25 cl / 8 4/9 oz
FDCU20 20 cl / 6 3/4 oz
12



Mug
Chope
Becher
Mug
Mug
FDMU30 30 cl / 10 1/7 oz
12



Saucer for tea/coffee cup
Soucoupe pour tasse à thé/café
Untere für Tee- /Kaffeetasse
Platillo para taza a té/café
Piattino per tazza da tè/caffè
FDSA15 > FDCU25 / FDCU20
15 cm / 6"
12

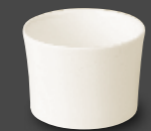

Breakfast cup without handle
Tasse à déjeuner sans anse
Frühstückstasse ohne Henkel
Taza de desayuno sin asa
Tazza da colazione senza manici
FDCU30M1 30 cl / 10 1/7 oz
12



Saucer for breakfast cup
Soucoupe pour tasse à déjeuner
Untere für Frühstückstasse
Platillo para taza de desayuno
Piattino per tazza da colazione
FDSA17 > FDMU30 / FDCU30M1 17 cm / 6 2/3"
12



Espresso Cup
Tasse à espresso
Espressotasse
Taza a expreso
Tazza da espresso
FDCU09 9 cl / 3 oz
12



Square saucer for breakfast cup
Soucoupe carrée pour tasse à déjeuner
Untere quadratisch für Frühstückstasse
Platillo cuadrado para taza de desayuno
Piattino quadrato per tazza da colazione
OPSA14 > FDMU30 / FDCU30M1 / FDCU30
14 cm / 5 1/2"
12



Coffee pot & lid
Cafetière & couvercle
Kaffeekanne & Deckel
Cafetera & tapa
Caffettiera & coperchio
FDCP70 70 cl / 23 2/3 oz
FDCP35 35 cl / 11 5/6 oz
4

Lid for coffee pot
Couvercle pour cafetière
Deckel für Kaffeekanne
Tapa para cafetera
Coperchio per caffettiera
FDCPLD2 > FDCP70
FDCPLD1 > FDCP35
12



Creamer
Crémier
Milchkännchen
Lechera
Bricco da latte
FDCR40 40 cl / 13 1/2 oz
FDCR25 25 cl / 8 4/9 oz
FDCR15 15 cl / 5 oz
6
FDCR05 5 cl / 1 2/3 oz
24



Sugar bowl & lid
Sucrier & couvercle
Zuckerdose & Deckel
Azucarero & tapa
Zuccheriera & coperchio
FDSU22 22 cl / 7 3/7 oz
6



Teapot & lid
Théière & couvercle
Teekanne & Deckel
Tetera & tapa
Teiera & coperchio
FDTP80 80 cl / 27 oz
FDTP40 40 cl / 13 1/2 oz
4

Lid for teapot
Couvercle pour théière
Deckel für Teekanne
Tapa para tetera
Coperchio per teiera
FDTPLD2 > FDTP80
FDTPLD1 > FDTP40
12



Pepper shaker
Poivrier
Pfefferstreuer
Pimentero
Pepiera
FDPS01
6



Salt shaker
Salière
Salzstreuer
Salero
Saliera
FDSS01
6



En

GOLDEN puts celebration at the heart of tasting. A variation on the WHITE GOLD shape with prestigious gilded marks, it offers luxurious decoration and an exceptional atmosphere.

Fr

GOLDEN met la fête au cœur de la dégustation. Variation sur la forme WHITE GOLD avec le prestige de notes dorées, elle propose un décor luxueux et une atmosphère d'exception.

De

GOLDEN macht aus jedem Essen ein einziges Fest. Die mit Goldverzierungen versehene Variation der Kollektion WHITE GOLD bietet ein Luxusdekor in einer außergewöhnlichen Atmosphäre.

Es

GOLDEN trae la alegría al corazón de la degustación. Variación de la forma WHITE GOLD con el lujo de los toques dorados: GOLDEN propone una decoración lujosa y una atmósfera de excepción.

It

GOLDEN rende allegra la degustazione. Variazione della forma WHITE GOLD con il prestigio di note dorate, propone un decoro lussuoso e un'atmosfera d'eccezione.





KING GOLDEN

Serving tray rectangular

Plat rectangulaire
Platte rechteckig
Bandeja servicio rectangular
Vassoio da portata rettangolare

KQRT42 42 x 32.5 cm
16 1/2 x 12 4/5"

6



Square plate

Assiette carrée
Teller quadratisch
Plato cuadrado
Piatto quadrato

KQSP34 34 x 34 cm
13 2/5 x 13 2/5"

6



KQSP26 26 x 26 cm
10 1/4 x 10 1/4"

12



QUEEN GOLDEN

Round plate

Assiette ronde
Teller rund
Plato redondo
Piatto rotondo

KQRP31 31 cm / 12 1/5"

6



Round plate

Assiette ronde
Teller rund
Plato redondo
Piatto rotondo

KQRP22 22 cm / 8 2/3"

12

KQRP16 16 cm / 6 2/7"

24

Pieces per box
Pièces par boîte
Stück pro Karton
Piezas por caja
Pezzi per scatola



PRINCE GOLDEN

Deep plate

Assiette creuse
Teller tief
Plato hondo
Piatto fondo

KQDP29 29 cm / 11 3/7"

KQDP23 23 cm / 9"

6



PRINCESS GOLDEN

Scallop plate

Assiette festonnée
Teller festoniert
Plato scallop
Piatto smerlato

KQSP33 33 cm / 13"

6



Soup tureen & lid

Soupière & couvercle
Suppenterrine & Deckel
Sopera & tapa
Zuppiera & coperchio

KQSB340 340 cl / 115 oz

1

These items or collections are custom made, so please allow additional time for delivery.

Ces articles ou collections sont produits à la demande, prévoir un délai d'approvisionnement supplémentaire.

Diese Artikel oder Kollektionen werden entsprechend der Nachfrage hergestellt, eine zusätzliche Lieferzeit einplanen.

Estos artículos o colecciones se fabrican en función de la demanda. Debe fijarse un período de abastecimiento adicional.

Questi articoli o collezioni sono prodotti su richiesta, si prega di quindi di prevedere un termine di consegna supplementare



Tea cup

Tasse à thé
Teetasse
Taza a té
Tazza da tè

KQCU21 21 cl / 7 oz

12



Bowl

Bol
Schale
Bol
Copetta

KQCU21M 21 cl / 7 oz

12



Saucer

Soucoupe
Untere
Platillo
Piattino

KQSA15 > KQCU21M
KQCU21

15 cm / 6"

12



Espresso cup

Tasse à espresso
Espressotasse
Taza a expreso
Tazza da espresso

KQCU09 9 cl / 3 oz

12



Bowl

Bol
Schale
Bol
Copetta

KQCU09M 9 cl / 3 oz

12



Saucer

Soucoupe
Untere
Platillo
Piattino

KQSA12 > KQCU09M
KQCU09

12 cm / 4 5/7"

12





Coffee pot & lid
Cafetière & couvercle
Kaffeekanne & Deckel
Cafetera & tapa
Caffettiera & coperchio
KQCP160 160 cl / 54 oz
📦4 ⌚



Creamer
Crémier
Milchkännchen
Lechera
Bricco da latte
KQCR25 25 cl / 8 4/9 oz
📦6 ⌚



Teapot & lid
Théière & couvercle
Teekanne & Deckel
Tetera & tapa
Teiera & coperchio
KQTP150 150 cl / 50 5/7 oz
📦4 ⌚



Sugar bowl & lid
Sucrier & couvercle
Zuckerdose & Deckel
Azucarero & tapa
Zuccheriera & coperchio
KQSU25 25 cl / 8 4/9 oz
📦6 ⌚



⌚ These items or collections are custom made, so please allow additional time for delivery.
Ces articles ou collections sont produits à la demande, prévoir un délai d'approvisionnement supplémentaire.
Diese Artikel oder Kollektionen werden entsprechend der Nachfrage hergestellt, eine zusätzliche Lieferzeit einplanen.
Estos artículos o colecciones se fabrican en función de la demanda. Debe fijarse un período de abastecimiento adicional.
Questi articoli o collezioni sono prodotti su richiesta, si prega di quindi di prevedere un termine di consegna supplementare

En

The relief decoration of LEON gives it incomparable originality, strength of character and splendour. The range marries geometric shapes and durability with modernity.

Fr

Le décor en relief de LEON lui confère une originalité, une force de caractère et un éclat incomparables. La gamme marie formes géométriques, modernité et robustesse.

De

Das Reliefdekor der Kollektion LEON vermittelt Originalität sowie gleichermaßen Kraft, Charakter und einen unvergleichlichen Glanz. Diese Kollektion vereint geometrische Formen, moderne Akzente und Robustheit.

Es

La decoración en relieve de LEON le confiere una originalidad, una fuerza de carácter y un brillo incomparables. La gama combina formas geométricas, modernidad y robustez.

It

La decorazione in rilievo conferisce alla linea LEON incomparabile originalità, forza di carattere e brillantezza. La collezione sposa forme geometriche, modernità e robustezza.





Flat plate

Assiette plate
Teller flach
Plato llano
Piatto piano

BAFP31D1 31 cm / 12 1/5"
6

BAFP30D1 30 cm / 11 4/5"
6

BAFP29D1 29 cm / 11 3/7"
BAFP27D1 27 cm / 10 5/8"

12
BAFP25D1 25 cm / 9 5/6"

12
BAFP24D1 24 cm / 9 4/9"

12
BAFP23D1 23 cm / 9"

12
BAFP21D1 21 cm / 8 1/4"

24
BAFP20D1 20 cm / 7 7/8"
BAFP19D1 19 cm / 7 1/2"

24
BAFP17D1 17 cm / 6 2/3"
BAFP15D1 15 cm / 6"

24



Deep plate

Assiette creuse
Teller tief
Plato hondo
Piatto fondo

BADP30D1 30 cm / 11 4/5"
6

BADP26D1 26 cm / 10 1/4"
BADP23D1 23 cm / 9"

12



Steak plate

Assiette à steak
Steakteller
Plato steak
Piatto per bistecca

BAOP30D1 30 x 25,5 cm
11 4/5 x 10"

6



Oval platter

Plat ovale
Platte oval
Fuente oval
Piatto ovale

BAOP38D1 38 x 26 cm - 15 x 10 1/4"
BAOP32D1 32 x 22 cm - 12 3/5 x 8 2/3"

6
BAOP22D1 22 x 15,5 cm - 8 2/3 x 6 1/9"

12



Bowl

Bol
Schale
Bol
Coppetta

BABW14D1 14 cm - 6 cm - 63 cl
5 1/2" - 2 1/3" - 21 2/7 oz

12



Cream soup bowl, 2 handles

Tasse bouillon, 2 anses
Suppentasse, 2 Henkel
Bol consommé, 2 asas
Scodella per zuppa, 2 manici

BACS30D1 10,5 cm - 5,5 cm - 30 cl
4 1/7" - 2 1/5" - 10 1/7 oz

6



Saucer

Soucoupe
Untere
Platillo
Piattino

BAST01D1 > **BACS30D1**
17 cm / 6 2/3"

12



Salad bowl

Saladier
Salatschale
Ensaladera
Insalatiera

BASP25D1 25 cm - 11 cm - 200 cl
9 5/6" - 4 1/3" - 67 3/5 oz

1
BASP20D1 20 cm - 8 cm - 105 cl
7 7/8" - 3 1/7" - 35 1/2 oz

BASP16D1 16 cm - 7,5 cm - 67 cl
6 2/7" - 3" - 22 2/3 oz

12



Stackable salad bowl

Saladier empilable
Salatschale stapelbar
Ensaladera apilable
Insalatiera impilabile

BASB21D1 21 cm - 7,5 cm - 118 cl
8 1/4" - 3" - 39 8/9 oz

BASB16D1 16 cm - 7 cm - 60 cl
6 2/7" - 2 5/7" - 20 2/7 oz

12



Stackable cup high

Tasse empilable haute
Tasse stapelbar hoch
Taza apilable alta
Tazza impilabile alta

BACU20D1 20 cl / 6 3/4 oz
BACU09D1 9 cl / 3 oz

12



Stackable cup

Tasse empilable
Tasse stapelbar
Taza apilable
Tazza impilabile

BACU23D1 23 cl / 7 7/9 oz
BACU18D1 18 cl / 6 oz

12



Saucer

Soucoupe
Untere
Platillo
Piattino

BASA15D1 > **BACU23D1**
BACU20D1
BACU18D1
15 cm / 6"

12



Saucer

Soucoupe
Untere
Platillo
Piattino

BASA13D1 > **BACU09D1**
13 cm / 5 1/8"

12





Creamer
Crémier
Milchkännchen
Lechera
Bricco da latte
BACR25D1 25 cl / 8 4/9 oz
📦 6 🕒



Egg cup
Coquetier
Eierbecher
Huevera
Portauovo
BAEG01D1
📦 6 🕒

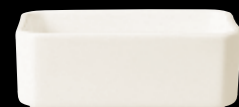

Sugar pack holder
Sucrier sachets
Zuckertütenschale
Azucarero sobres
Contenitore per pacco di zucchero
BASH01D1 11 x 7 - 4 cm
4 1/3 x 2 3/4" - 1 4/7"
📦 6 🕒



Pepper shaker
Poivrier
Pfefferstreuer
Pimentero
Pepiera
BAPS01D1
📦 6 🕒



Salt shaker
Salière
Salzstreuer
Salero
Saliera
BASS01D1
📦 6 🕒



Sugar bowl & lid
Sucrier & couvercle
Zuckerdose & Deckel
Azucarero & tapa
Zuccheriera & coperchio
BASU27D1 27 cl / 9 1/8 oz
📦 6 🕒

Lid for sugar bowl
Couvercle pour sucrier
Deckel für Zuckerdose
Tapa para azucarero
Coperchio per zuccheriera
BASULDD1
📦 12 🕒

📦 Pieces per box
Pièces par boîte
Stück pro Karton
Piezas por caja
Pezzi per scatola

🕒 Extra time for deliveries
Délai supplémentaire
Zusätzliche Lieferzeit
Período de abastecimiento adicional
Termine di consegna supplementare



En

LINE-Z's delicate streaks create an original visual effect with concentric circles on bright porcelain, for spectacular presentations.

Fr

Les stries délicates de LINE-Z créent un effet visuel original avec des cercles concentriques sur une porcelaine éclatante, pour des présentations spectaculaires.

De

Die dezente Riffelung der Kollektion LINE-Z erzeugt einen originellen optischen Effekt mit konzentrischen Kreisen auf brillantweißem Porzellan für spektakuläre Präsentationen.

Es

Las delicadas estrías de LINE-Z aportan un original efecto visual con círculos concéntricos sobre una porcelana brillante que permiten crear presentaciones espectaculares.

It

Le delicate striature della collezione LINE-Z creano un effetto visivo originale, con cerchi concentrici sulla porcellana risplendente, per spettacolari presentazioni.



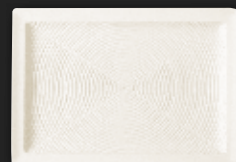

Rectangular flat plate
Assiette plate rectangulaire
Teller flach rechteckig
Plato llano rectangular
Piatto piano rettangolare

LZRP38 38 x 21 cm
15 x 8 1/4"

LZRP33 33 x 23 cm
13 x 9"



LZRP29 29 x 12 cm
11 3/7 x 4 5/7"



LZRP26 26 x 8 cm
10 1/4 x 3 1/7"

LZRP23 21 x 7 cm
8 1/4 x 2 3/4"



Square flat plate
Assiette plate carrée
Teller flach quadratisch
Plato llano cuadrado
Piatto piano quadrato

LZSP30 30 cm / 11 4/5"



Round flat plate
Assiette plate ronde
Teller flach rund
Plato llano redondo
Piatto piano rotondo

LZFP31 31 cm / 12 1/5"



LZFP27 27 cm / 10 5/8"

LZFP24 24 cm / 9 4/9"



LZFP21 21 cm / 8 1/4"

LZFP17 17 cm / 6 2/3"

LZFP15 15 cm / 6"



Round deep plate
Assiette creuse ronde
Teller tief rund
Plato hondo redondo
Piatto fondo rotondo

LZDP30 30 cm / 11 4/5"



LZDP24 24 cm / 9 4/9"



**Non stackable cup
(Classic-Gourmet)**
Tasse non empilable
(Classic-Gourmet)
Tasse nicht stapelbar
(Classic-Gourmet)
Taza no apilable (Classic-Gourmet)
Tazza non impilabile
(Classic-Gourmet)

CLCU28 28 cl / 9 1/2 oz

CLCU23 23 cl / 7 7/9 oz

CLCU20 20 cl / 6 3/4 oz

CLCU09 9 cl / 3 oz



Saucer
Soucoupe
Untere
Platillo
Piattino

LZSA17 > CLCU28

17 cm / 6 2/3"

LZSA15 > CLCU23 / CLCU20

15 cm / 6"

LZSA13 > CLCU09

13 cm / 5 1/8"



En

LYRA's natural elegance with its arched silhouette and graceful line make it possible to create harmonious and varied presentations.

Fr

L'élégance naturelle de LYRA avec sa silhouette galbée et sa ligne gracieuse permet des présentations harmonieuses et variées.

De

Die natürliche Eleganz der Kollektion LYRA mit der gerundeten Silhouette und der graziösen Linie ermöglichen ein harmonisches und abwechslungsreiches Anrichten.

Es

La elegancia natural de LYRA, con su silueta curvada y su atrayente línea, permite realizar presentaciones armoniosas y variadas.

It

L'eleganza naturale di LYRA con la sua silhouette curvilinea e le sue linee morbide assicura presentazioni armoniose e varie.

DESIGN BY MIKAELA DOERFEL





Flat plate
Assiette plate
Teller flach
Plato llano
Piatto piano

LRFP31 31 cm / 12 1/5"
6

LRFP29 29 cm / 11 3/7"
LRFP27 27 cm / 10 5/8"
LRFP24 24 cm / 9 4/9"
LRFP21 21 cm / 8 1/4"

12

LRFP19 19 cm / 7 1/2"
24

LRFP17 17 cm / 6 2/3"
LRFP15 15 cm / 6"

24



Oval platter
Plat ovale
Platte oval
Fuente oval
Piatto ovale

LROP38 38 x 27 cm
15 x 10 5/8"

LROP32 32 x 22.5 cm
12 3/5 x 8 6/7"

6

LROP22 22 x 15.5 cm
8 2/3" x 6 1/9"

12



Stackable salad bowl
Saladier empilable
Salatschale stapelbar
Ensaladera apilable
Insalatiera impilabile

LRSB18 18 cm - 29 cl
7" - 9 4/5 oz

LRSB12 12 cm - 15 cl
4 5/7" - 5 oz

12



Deep plate
Assiette creuse
Teller tief
Plato hondo
Piatto fondo

LRDP30 30 cm / 11 4/5"
6

LRDP26 26 cm / 10 1/4"
LRDP23 23 cm / 9"

12



Non stackable soup bowl
Tasse à bouillon non empilable
Suppentasse nicht stapelbar
Bol consommé no apilable
Scodella per zuppa non impilabile

LRCN30 12 cm - 7.5 cm - 30 cl
4 5/7" - 3" - 10 1/7 oz

12



Stackable soup bowl
Tasse à bouillon empilable
Suppentasse stapelbar
Bol consommé apilable
Scodella per zuppa impilabile

LRCN30 10.5 cm - 6 cm - 30 cl
4 1/7" - 2 1/3" - 10 1/7 oz

12



Saucer
Soucoupe
Untere
Platillo
Piattino

LRSA17 > LRCN30 / LRCS30
17 cm / 6 2/3"

12



Non stackable cup
Tasse non empilable
Tasse nicht stapelbar
Taza no apilable
Tazza non impilabile

LRCU27 27 cl / 9 1/8 oz
LRCU22 22 cl / 7 3/7 oz

LRCU18 18 cl / 6 oz
12



Stackable cup
Tasse empilable
Tasse stapelbar
Taza apilable
Tazza non impilabile

LRSC27 27 cl / 9 1/8 oz
LRSC22 22 cl / 7 3/7 oz

LRSC18 18 cl / 6 oz
12



Saucer
Soucoupe
Untere
Platillo
Piattino

LRSA17 > LRCU27 / LRSC27
17 cm / 6 2/3"

LRSA15 > LRCU22 / LRCU18 / LRSC22 / LRSC18

15 cm / 6"
12



Non stackable cup
Tasse non empilable
Tasse nicht stapelbar
Taza no apilable
Tazza non impilabile

LRCU09 9 cl / 3 oz
12



Stackable cup
Tasse empilable
Tasse stapelbar
Taza apilable
Tazza non impilabile

LRSC09 9 cl / 3 oz
12



Saucer
Soucoupe
Untere
Platillo
Piattino

LRSA12 > LRCU09 / LRSC09
12 cm / 4 5/7"

12



Tajine cover for deep plate
Couvercle tajine pour assiette creuse
Tajine Deckel für tiefe Teller
Tapa tajine para plato hondo
Coperchio tajine per piatto fondo

LRCV27 > LRDP30
LRCV23 > LRDP26
LRCV20 > LRDP23

1





Sugar bowl & lid
Sucrier & couvercle
Zuckerdose & Deckel
Azucarero & tapa
Zuccheriera & coperchio

LRSU27 27 cl / 9 1/8 oz

6

Lid for sugar bowl

Couvercle pour sucrier
Deckel für Zuckerdose
Tapa para azucarero
Coperchio per zuccheriera

LRSULD

12



Teapot & lid
Théière & couvercle
Teekanne & Deckel
Tetera & tapa
Teiera & coperchio

LRTP40 40 cl / 13 1/2 oz

4

Lid for teapot

Couvercle pour théière
Deckel für Teekanne
Tapa para tetera
Coperchio per teiera

LRTPLD

12



Creamer
Crémier
Milchkännchen
Lechera
Bricco da latte

LRCR25 25 cl / 8 4/9 oz

LRCR15 15 cl / 5 oz

6



Egg cup
Coquetier
Eierbecher
Huevera
Portauovo

LREG01

12



Coffee pot & lid
Cafetière & couvercle
Kaffeekanne & Deckel
Cafetera & tapa
Caffettiera & coperchio

LRCP35 35 cl / 11 5/6 oz

4

Lid for coffee pot

Couvercle pour cafetière
Deckel für Kaffeekanne
Tapa para cafetera
Coperchio per caffettiera

LRCPLD

12



Salt shaker
Salière
Salzstreuer
Salero
Saliera

LRSS01

12



Pepper shaker
Poivrier
Pfefferstreuer
Pimentero
Pepiera

LRPS01

12



Flower vase
Vase
Blumenvase
Florero
Vaso

LRFV01

6

6 Pieces per box
Pièces par boîte
Stück pro Karton
Piezas por caja
Pezzi per scatola

Extra time for deliveries
Délai supplémentaire
Zusätzliche Lieferzeit
Periodo de abastecimiento adicional
Termine di consegna supplementare



En

Thanks to designers Dominique and Alain Vavro, working together with the artistry of Marseille's Michelin-starred chef Gérald Passédat, MASSILIA combines a fresh design with impeccable symmetry to provide the perfect framework for the most exquisite gastronomic creations.

Fr

Grâce aux designers Dominique et Alain Vavro, alliés à l'œil créatif du chef étoilé marseillais Gérald Passédat, MASSILIA apporte une touche de fraîcheur d'une symétrie impeccable pour encadrer les réalisations gastronomiques les plus savantes.

De

Dank den Designern Dominique und Alain Vavro, zusammen mit dem professionellen Auge des besten Küchenchefs Gérald Passédat, beinhaltet MASSILIA, in ihrer symmetrischen Formgebung die Anmutung der Frische, um eine Präsentationsbasis für feinste Kreationen zu sein.

Es

Gracias a los diseñadores Dominique y Alain Vavro, aliados del ojo creativo del chef marsellés Gérald Passédat, galardonado con dos estrellas, MASSILIA aporta un toque de frescura con una simetría impecable para enmarcar las más sabias realizaciones gastronómicas.

It

Grazie ai designer Dominique e Alain Vavro e all'occhio creativo dello chef stellato marsigliese Gérald Passédat, MASSILIA dona un tocco di freschezza e una simmetria impeccabile, per incorniciare le pietanze più prelibate.





Square plate
Assiette carrée
Teller quadratisch
Plato cuadrado
Piatto quadrato

MSFP30 30 cm / 11 4/5"



MSFP27 27 cm / 10 3/5"

MSFP20 20 cm / 7 4/5"



Square bread plate
Assiette à pain carrée
Brotplatte quadratisch
Plato de pan cuadrado
Piatto da pane quadrato

MSFP14 14.5 cm / 5 5/7"

MSFP12 12 cm / 4 5/7"



Rectangular deep plate
Assiette creuse
rectangulaire
Teller tief rechteckig
Plato hondo rectangular
Piatto fondo rettangolare

MSDP27 27 x 21 cm - 55 d

10 1/2 x 8 1/5" - 18 3/5 oz



**Cloche for rectangular
deep plate**

Cloche pour assiette
creuse rectangulaire
Cloche für Teller tief
rechteckig
Campana para plato
hondo rectangular
Coperchio per piatto
fondo rettangolare

MSDP27LD > MSDP27



Coffee/tea cup
Tasse à café/thé
Kaffee-/Teetasse
Taza a café/té
Tazza da caffè/tè

MSCU17 8 cm - 17 cl

3 1/7" - 5 5/7 oz



Coffee/tea cup without handle
Tasse à café/thé sans anse
Kaffee-/Teetasse ohne Henkel
Taza a café/té sin asa
Tazza da caffè/tè senza manici

MSCU17M 8 cm - 17 cl

3 1/7" - 5 5/7 oz



Saucer for Coffee/tea cup
Soucoupe pour tasse à café/thé
Untere für Kaffee-/Teetasse
Platillo para taza a café/té
Piatino per tazza da caffè/tè

MSSA14 > MSCU17 / MSCU17M

14.5 cm / 5 5/7"



Espresso cup
Tasse à espresso
Espressotasse
Taza a expreso
Tazza da espresso

MSCU10 6 cm - 11 cl

2 1/3" - 3 2/3 oz



Espresso cup without handle
Tasse à expreso sans anse
Espressotasse ohne Henkel
Taza a expreso sin asa
Tazza da espresso senza manici

MSCU10M 6 cm - 11 cl

2 1/3" - 3 2/3 oz



Saucer for Espresso cup
Soucoupe pour tasse à espresso
Untere für Espressotasse
Platillo para taza a expreso
Piatino per tazza da espresso

MSSA12 > MSCU10 / MSCU10M

12 cm / 4 5/7"



**Rectangular tray,
2 indents**
Plat rectangulaire,
2 empreintes
Platte rechteckig,
2 Ringe
Fuente rectangular,
2 estanques
Vassoio rettangolare,
2 inserti

MSRIN33 33 x 22 cm
13 x 8 2/3"

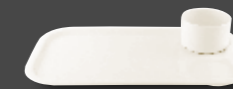

**Square tray,
2 indents**
Plat carré,
2 empreintes
Platte quadratisch,
2 Ringe
Fuente cuadrada,
2 estanques
Vassoio quadrato,
2 inserti

MSSIN22 20 cm

7 7/8"



En

Bold and graceful, the MAZZA items are the perfect palette for your most avant-garde creations. Its novel and diverse shapes, inspired by the current fusion-food movement, offer endless variations for the most contemporary of presentations.

Fr

Audacieuse et svelte, la gamme MAZZA sert de cadre idéal à vos créations les plus avantgardistes. Ses formes inédites et variées, nées du courant fusion-food offrent diverses déclinaisons pour des mises en scène très contemporaines.

De

Die kühne und graziöse Kollektion MAZZA bildet den idealen Rahmen für avantgardistische Kreationen. Die neuen und abwechslungsreichen, von der aktuellen Fusion-Food-Welle inspirierten Formen bieten verschiedenste Möglichkeiten, Ihre Kompositionen auf zeitgenössische Weise in Szene zu setzen.

Es

La gama MAZZA, audaz y esbelta, sirve de marco ideal para sus creaciones más vanguardistas. Sus formas inéditas y variadas, nacidas de la corriente de cocina de fusión, ofrecen diversas declinaciones para crear puestas en escena muy contemporáneas.

It

Audace e scattante, la gamma MAZZA offre una cornice ideale alle vostre creazioni più all'avanguardia. Le sue forme inedite ed eterogenee, nate dalla corrente soprannominata "fusion", propongono varie declinazioni per presentazioni decisamente contemporanee.





Square flat plate
Assiette plate carrée
Teller flach quadratisch
Plato llano cuadrado
Piatto piano quadrato

MZSP32 32 x 29 cm
12 3/5 x 11 3/7"
MZSP26 26 x 23.5 cm
10 1/4 x 9 1/5"
MZSP20 20 x 18 cm
7 7/8 x 7"

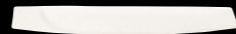

Baguette tray
Plat baguette
Platte baguette
Bandeja baguette
Vassoio baguette

MZBP50 50 x 11 cm
19 2/3 x 4 1/3"
MZBP44 44 x 10.5 cm
17 1/3 x 4 1/6"
MZBP38 38 x 10 cm
15 x 4"

MZBP26 26 x 10 cm
10 1/4 x 4"
MZBP20 20 x 7.5 cm
7 7/8 x 3"



Rectangular flat plate
Assiette plate rectangulaire
Teller flach rechteckig
Plato llano rectangular
Piatto piano rettangolare

MZRP32 32 x 21 cm
12 3/5 x 8 2/9"
MZRP26 26 x 17 cm
10 1/4 x 6 2/3"
MZRP20 20 x 13 cm
7 7/8 x 5 1/8"



Twin plate
Plat twin
Platte twin
Plato doble twin
Piatto twin

MZTM53 53 x 17 cm
20 6/7 x 6 2/3"
MZTW53 53 x 30 cm
20 6/7 x 11 4/5"
MZTP42 42 x 11 cm
16 1/2 x 4 1/3"
MZTP32 32 x 10 cm
12 3/5 x 4"



Cocktail plate
Assiette cocktail
Cocktailteller
Plato cóctel
Piatto cocktail

MZCP32 32 x 9.5 cm
12 3/5 x 3 5/7"
MZCP26 26 x 7.5 cm
10 1/4 x 3"
MZCP20 20 x 6.5 cm
7 7/8 x 2 1/2"



Ellipse plate
Plat ellipse
Platte elipse
Plato elipse
Piatto ellisse

MZEP32 32 x 21 cm
12 3/5 x 8 2/9"
MZEP26 26 x 17 cm
10 1/4 x 6 2/3"
MZEP20 20 x 13 cm
7 7/8 x 5 1/8"



Mini rectangular dish
Coupelle rectangulaire
Schale rechteckig
Rabanera mini rectangular
Mini coppetta rettangolare

MZMR11 11 x 5.5 cm
4 1/4 x 2 1/8"



Mini square dish
Coupelle carrée
Schale quadratisch
Rabanera mini cuadrada
Mini coppetta quadrata

MZMS08 8 x 7.5 cm
3 1/7 x 3"



Icon of a box with 6 pieces
Pieces per box
Pièces par boîte
Stück pro Karton
Piezas por caja
Pezzi per scatola



COLLECTION
METROPOLIS

CASUAL DINING

141

En

METROPOLIS creates a cosmopolitan, chic and urban atmosphere, with a hint of retro. Its relief which is pleasant to touch, emits a tasty shine.

Fr

METROPOLIS crée une atmosphère cosmopolite, chic et citadine avec une touche retro. Son relief agréable au toucher diffuse une lumière savoureuse.

De

Die Kollektion METROPOLIS verbreitet eine kosmopolitische, elegante und städtische Atmosphäre mit einem leichten Retro-Touch. Ihr angenehm anzuführendes Relief sorgt für genussvolle Lichtreflexionen.

Es

METROPOLIS crea una atmósfera cosmopolita, elegante y urbana con un toque retro. Su relieve agradable al tacto emite una luz sabrosa.

It

METROPOLIS crea un'atmosfera cosmopolita, chic e cittadina con un tocco retrò. Il rilievo piacevole al tatto diffonde una luce gradevole.





Flat plate
Assiette plate
Teller flach
Plato llano
Piatto piano

MEFP31 31 cm / 12 1/5"
6

MEFP29 29 cm / 11 3/7"

MEFP27 27 cm / 10 5/8"

MEFP24 24 cm / 9 4/9"

12

MEFP21 21 cm / 8 1/4"

MEFP17 17 cm / 6 2/3"

MEFP15 15 cm / 6"

24



Coffee cup
Tasse à café
Kaffeetasse
Taza a café
Tazza da caffè

MECU20 20 cl / 6 3/4 oz

12



Saucer for coffee cup
Soucoupe pour tasse à café
Untere für Kaffeetasse
Platillo para taza a café
Piattino per tazza da caffè

MESA15 > MECU20

15 cm / 6"

12



Deep plate
Assiette creuse
Teller tief
Plato hondo
Piatto fondo

MEDP30 30 cm / 11 4/5"

6

MEDP26 26 cm / 10 1/4"

MEDP23 23 cm / 9"

12



Espresso cup
Tasse à espresso
Espressotasse
Taza a expreso
Tazza da espresso

MECU09 9 cl / 3 oz

12



Saucer for espresso cup
Soucoupe pour tasse à espresso
Untere für Espressotasse
Platillo para taza a expreso
Piattino per tazza da espresso

MESA13 > MECU09

13 cm / 5 1/8"

12



Coffee cup
Tasse à café
Kaffeetasse
Taza a café
Tazza da caffè

MECU35 35 cl / 12 1/3 oz

12



Saucer for coffee cup
Soucoupe pour tasse à café
Untere für Kaffeetasse
Platillo para taza a café
Piattino per tazza da caffè

MESA17 > MECU35

17 cm / 6 2/3"

12



Creamer
Crémier
Milchkännchen
Lechera
Bricco da latte

MECR15 15 cl / 5 oz

6

Pieces per box
Pièces par boîte
Stück pro Karton
Piezas por caja
Pezzi per scatola



En

MINIMAX is eclectic and full of good ideas, offering a range of items to be used alone or combined harmoniously with other collections. The variety of small and large sizes provide innovative solutions for serving your most unusual culinary creations.

Fr

Éclectique et pleine de bonnes idées, MINIMAX propose une gamme d'articles à utiliser seuls ou en harmonie avec d'autres collections. L'assortiment de petites et grandes tailles procure des solutions originales à vos créations culinaires les plus insolites.

De

Mit offenem Design und voller spannender Ideen präsentiert sich die Kollektion MINIMAX gleichermaßen als eigenständige Serie und als harmonische Ergänzung anderer Kollektionen. Die große Auswahl an kleinen und großen Formen eröffnet innovative Lösungen für Ihre außergewöhnlichen kulinarischen Kreationen.

Es

Ecléctica y repleta de buenas ideas, Minima propone una gama de artículos para utilizar solos o en armonía con otras colecciones. El conjunto de pequeños y grandes tamaños aporta soluciones originales a sus creaciones culinarias más insólitas.

It

Eclettica e piena di idee eccezionali, la linea MINIMAX propone una gamma di articoli da usare singolarmente o insieme ad altre collezioni. Grazie a un assortimento di taglie piccole e grandi, offre soluzioni originali in grado di soddisfare le creazioni culinarie più insolite.



**PLATTERS AND PLATES
PLATS ET ASSIETTES
PLATTEN UND TELLER
FUENTES Y PLATOS
VASSOI I PIATTI**



Island platter
Plat île
Inselplatte
Bandeja isla
Vassoio isola

NAIP39 39 x 31 cm
15 1/3 x 12 1/5"
NAIP33 33 x 27.5 cm
13 x 10 5/6"



Leaf bowl
Bol feuille
Blattschale
Bol hoja
Coppetta foglia

NABW28 28.5 x 17 cm - 63 cl
11 2/9 x 6 2/3" - 21 2/7 oz
NABW22 22 x 14.5 cm - 45 cl
8 2/3 x 5 5/7" - 15 1/5 oz

NABW16 16.5 x 12 cm - 20 cl
6 1/2 x 4 5/7" - 6 3/4 oz



Leaf plate
Plat feuille
Blattplatte
Plato hoja
Piatto foglia

NAOP48 48.5 x 30 cm
19 x 11 4/5"



NAOP38 38 x 25.5 cm
15 x 10"



Oval plate
Plat ovale
Platte oval
Plato oval
Piatto ovale

MNOP33 32.5 x 13.5 cm
12 4/5 x 5 1/3"



Half-moon platter
Plat demi-lune
Halbmondplatte
Plato media luna
Piatto mezzaluna

MNMP38 38.5 x 15.5 cm
15 1/6 x 6 1/9"



Service tray, 16 indents
Plat service, 16 encoches
Serviceplatte, 16 Flächen
Bandeja, 16 estanques
Vassoio da portata, 16 inserti

LXST39 > SPCU09 39 x 28 cm
15 1/3 x 11"



Cup without handle
Tasse sans anse
Tasse ohne Henkel
Taza sin asa
Tazza senza manici

SPCU09 > LXST39 9 cl / 3 oz



Drop shaped platter
Plat en forme de goutte
Platte in Tropfenform
Plato en forma de gota
Piatto a goccia

ACDS01 35.5 x 18.5 cm
14 x 7 2/7"

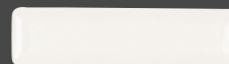

Rectangular long dish
Plat long rectangulaire
Platte lang rechteckig
Plato largo rectangular
Piatto lungo rettangolare

OPRL40 40 x 10.5 cm
15 3/4 x 4 1/7"



Rectangular dish
Ravier rectangulaire
Schale rechteckig
Rabanera rectangular
Coppetta rettangolare

OPCD26 26 x 16 cm - 100 cl
10 1/4 x 6 2/7" - 33 4/5 oz

OPCD20 20 x 16 cm - 59 cl
7 7/8 x 6 2/7" - 20 oz



OPCD18 18 x 10.5 cm - 33 cl
7 x 4" - 11 3/5 oz



OPCD17 17 x 13 cm - 50 cl
6 2/3 x 5 1/8" - 17 oz

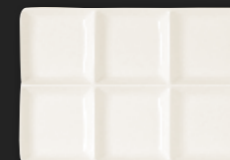

Rectangular plate, 6 compartments
Assiette rectangulaire,
6 compartiments
Platte rechteckig,
6 Vertiefungen
Plato rectangular,
6 compartimentos
Piatto rettangolare,
6 compartimenti

OPRP6C 28 x 20 cm
11 x 7 7/8"



Square plate, 4 compartments
Assiette carrée,
4 compartiments
Platte quadratisch,
4 Vertiefungen
Plato cuadrado,
4 compartimentos
Piatto quadrato,
4 compartimenti

OPSP4C 20 cm / 7 7/8"



Rectangular tray, 3 compartments
Plat rectangulaire,
3 compartiments
Platte rechteckig,
3 Vertiefungen
Bandeja rectangular,
3 compartimentos
Vassoio rettangolare,
3 compartimenti

OPRT19C 19 x 17 cm
7 1/2 x 6 2/3"

SPRP3C 19.5 x 12.5 cm
7 2/3 x 5"

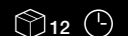

Rectangular tray
Plat rectangulaire
Platte rechteckig
Bandeja rectangular
Vassoio rettangolare

OPRT24 24 x 10 cm
9 4/9 x 4"



OPRT18 18 x 7.5 cm
7 x 3"





Bowl
Bol
Schale
Bol
Coppetta

NAMB37 37 cm - 7 cm - 120 cl
14 4/7" - 2 3/4" - 40 4/7 oz



NAMB31 31 cm - 8 cm - 95 cl
12 1/5" - 3 1/7" - 32 1/9 oz



NAMB27 27 cm - 6.5 cm - 70 cl
10 5/8" - 3 3/4" - 23 2/3 oz

NAMB16 16 cm - 3.5 cm - 12 cl
6 2/7" - 1 3/8" - 4 oz



Small rectangular tray
Plat rectangulaire petit
Platte rechteckig klein
Bandeja rectangular pequeña
Vassoio rettangolare piccolo

OPTR12 12 x 7.5 cm
4 5/7 x 3"



Snack plate
Plat à snack
Snackplatte
Plato snack
Vassoio snack

OPRP18 18 x 11.5 cm
7 x 4 1/2"



Square plate
Assiette carrée
Teller quadratisch
Plato cuadrado
Piatto quadrato

OPSP08 8 cm / 3 1/7"
OPSP06 6 cm / 2 1/3"



Half-moon plate
Assiette demi-lune
Teller Halbmond
Plato media luna
Piatto mezzaluna

OPMP01 21 x 12 cm
8 1/4 x 4 5/7"



Oval plate rimless
Plat ovale sans bord
Platte oval ohne Rand
Fuente oval sin borde
Piatto ovale senza falda

OPOP19 19 x 15.5 cm
7 1/2 x 6 1/9"

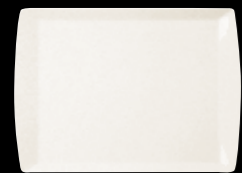

Sandwich tray
Plat à sandwich
Sandwichplatte
Bandeja sándwich
Vassoio sandwich

OPST39 39 x 28 cm
15 1/3 x 11"

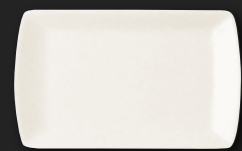

Sandwich tray
Plat à sandwich
Sandwichplatte
Bandeja sándwich
Vassoio sandwich

OPSP45 45 x 15 cm
17 5/7 x 6"



OPSP35 35 x 15 cm
13 7/9 x 6"

OPST24 24 x 14 cm
9 4/9 x 5 5/9"

OPSP14 14 x 8 cm
5 1/2 x 3 1/7"



Sandwich tray,
2 indents 55 mm / 2 1/4"
Plat à sandwich,
2 empreintes 55 mm/2 1/4"
Sandwichplatte,
2 Vertiefungen 55 mm/2 1/4"
Bandeja sándwich,
2 estanques 55 mm/2 1/4"
Vassoio sandwich,
2 inserti 55 mm/2 1/4"

OPSP35IN 35 x 15 cm
13 7/9 x 6"

OPSP14IN 13.5 x 8 cm
5 1/3 x 3 1/4"



DEEP PLATTERS
PLATS CREUX
PLATTEN TIEF
FUENTES HONDO
PIATTI FONDI

Square bowl
Bol carré

Schale quadratisch
Bol cuadrado
Coppetta quadrata

OPSB15 15 cm - 7 cm - 70 cl / 3 1/2" - 2 3/4" - 23 2/3 oz



OPSB12 12 cm - 3.5 cm - 20 cl / 4 5/7" - 1 3/8" - 6 3/4 oz



OPSB09 9 cm - 5 cm - 17 cl / 3 1/2" - 2" - 5 3/4 oz



OPSB08 8 cm - 4 cm - 10.5 cl / 3 1/7" - 1 4/7" - 3 5/9 oz



OPSB07 7 cm - 3.5 cm - 7 cl / 2 3/4" - 1 3/8" - 2 3/8 oz



OPSB04 4 cm - 2 cm - 2 cl / 1 4/7" - 4/5" - 2/3 oz



Triangular bowl

Bol triangulaire
Schale dreieckig
Bol triangular
Coppetta triangolare

OPTB12 12 cm - 25.5 cl / 4 5/7" - 8 5/8 oz

OPTB10 10 cm - 15.5 cl / 3 3/4" - 5 1/4 oz



Deep bowl boat
Bol profond bateau
Bootschale tief
Bol hondo barco
Coppetta fonda barca

MNDB116 23 x 13 cm - 10.5 cm - 116 cl
9 x 5 1/8" - 4 1/7" - 39 2/9 oz



Lid for deep bowl boat

Couvercle pour bol
profond bateau
Deckel für
Bootschale tief
Tapa para bol hondo barco
Coperchio per coppetta
fonda barca

MNDBLD01 > MNDB116



Deep bowl boat
Bol profond bateau
Bootschale tief
Bol hondo barco
Coppetta fonda barca

MNDB50 19.5 x 12 cm - 7 cm - 60 cl
7 2/3 x 4 3/5" - 2 3/4" - 20 2/7 oz



Bowl boat
Bol bateau
Bootschale
Bol barco
Coppetta barca

MNSB68 22.5 x 13.5 cm - 8 cm - 68 cl
8 6/7 x 5 1/3" - 3 1/7" - 23 oz





Boat dish
Plat bateau
Bootschale
Plato barco
Piatto barca

MNSB44 23 x 13 cm - 5.5 cm - 44 cl
9 x 5 1/8" - 2 1/5" - 14 7/8 oz



Lid for boat dish
Couvercle pour plat
bateau
Deckel für Bootschale
Tapa para plato barco
Coperchio per copetta
barca

MNSBLD01 > **MNSB44**



Boat dish
Plat bateau
Bootschale
Plato barco
Piatto barca

MNSB34 21 x 11.5 cm - 5.2 cm - 34 cl
8 1/5 x 4 1/2" - 2 5/9" -
11 1/2 oz



Bowl boat
Bol bateau
Bootschale
Bol barco
Coppetta barca

MNSB32 17 x 10.5 cm - 6.5 cm - 32 cl
6 2/3 x 4 1/7" - 2 5/9" -
10 4/5 oz



Mini boat bowl
Mini bol bateau
Mini Bootschale
Mini bol barco
Mini coppetta barca

MNOD09 15 x 8.5 cm - 3.5 cm - 11 cl
5 5/6 x 3 1/3" - 1 3/8" - 3 5/7 oz
MNOD05 7.3 x 4.5 cm - 3 cm - 3 cl
2 7/8 x 1 7/9" - 1 1/6" - 1 oz



Oval dish with grip
Plat à oreilles ovale
Schale oval mit Griffen
Plato oval con asas
Piatto ovale con alette

OPOD30 30 x 16 cm - 78 cl
11 4/5 x 6 2/7" - 26 3/8 oz



OPOD25 25 x 14 cm - 42 cl
9 5/6 x 5 1/2" - 14 1/5 oz



OPOD24 24 x 13 cm - 32.5 cl
9 4/9 x 5 1/8" - 11 oz

OPOD20 20 x 11 cm - 20 cl
7 7/8 x 4 1/3" - 6 3/4 oz

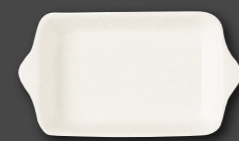

Rectangular dish with grip
Plat rectangulaire à poignées
Teller rechteckig mit Griffen
Plato rectangular con asas
Piatto rettangolare con manici

OPRT16 16.3 x 9.5 cm - 15 cl
6 3/7 x 3 3/4" - 5 oz



Stackable oval pie dish
Plat ovale empilable
Platte oval stapelbar
Plato oval apilable
Piatto per torta ovale impilabile

OPOS20 20 x 12 cm - 42 cl
7 7/8 x 4 5/7" - 14 1/5 oz



Pie dish
Plat à gratin
Platte für Gratin
Plato a gratin
Piatto per torta

OPPD15 15 x 11 cm - 28 cl
6 x 4 1/3" - 9 1/2 oz



Oval bowl stackable
Plat ovale empilable
Schale oval stapelbar
Cuenco oval apilable
Coppetta ovale impilabile

OPRB17 17 x 8 cm - 15 cl
6 2/3 x 3 1/7" - 5 oz



Round dish with grip
Plat à oreilles rond
Schale rund mit Griffen
Plato redondo con asas
Piatto rotondo con alette

OPRD16 21.5 x 18 cm - 45 cl
8 1/2 x 7" - 15 2/9 oz



ARTICLES WITH LID

**ARTICLES AVEC
COUVERCLE**

ARTIKEL MIT DECKEL

ARTÍCULOS CON TAPA

ARTICOLI CON COPERCHIO



Rectangular tureen & lid
Terrine rectangulaire & couvercle
Terrine rechteckig & Deckel
Tarrina rectangular & tapa
Terrina rettangolare & coperchio

OPTU23 23 x 18 cm - 14 cm - 160 cl
9 x 7" - 5 2/5" - 54 oz



OPTU20 20 x 15 cm - 12 cm - 104 cl
7 2/3 x 6" - 4 4/7" - 35 1/6 oz

OPTU16 16 x 13.5 cm - 10 cm - 60 cl
6 1/2 x 5 1/3" - 4" - 20 2/7 oz

OPTU15 15 x 12 cm - 9 cm - 39 cl
6 x 4 2/3" - 3 1/2" - 13 1/5 oz

OPTU13 13 x 10 cm - 8 cm - 30 cl
5 1/8 x 4" - 3" - 10 1/7 oz

OPTU12 12 x 9 cm - 7 cm - 20 cl
4 3/5 x 3 5/8" - 2 3/4" - 6 3/4 oz



Handi bowl & lid
Bol Handi & couvercle
Handi Schale & Deckel
Bol Handi & tapa
Coppetta bombata Handi
& coperchio

OPHB150 18.5 cm - 13 cm - 150 cl
7 2/7" - 5 1/8" - 50 5/7 oz

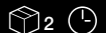

OPHB89 19.5 cm - 10 cm - 90 cl
7 2/3" - 4" - 30 3/7 oz



OPHB85 16.5 cm - 11 cm - 85 cl
6 1/2" - 4 1/3" - 28 3/4 oz

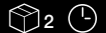

OPHB50 15.5 cm - 9 cm - 50 cl
6 1/9" - 3 1/2" - 17 oz



Lid for handi bowl

Couvercle pour bol Handi
Deckel für Handi Schale
Tapa para bol Handi
Coperchio per coppetta
bombata Handi

OPHBLD150 > **OPHB150**

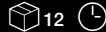

OPTBLD89 > **OPHB89**



OPHBLD85 > **OPHB85**

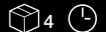

OPHBLD50 > **OPHB50**





Bowl & lid
Bol & couvercle
Schale & Deckel
Bol & tapa
Coppetta & coperchio
OPBW15 15 cm - 12.5 cm - 37 cl
6" - 5" - 12 1/2 oz



Lid for bowl
Couvercle pour bol
Deckel für Schale
Tapa para bol
Coperchio per coppetta
OPBWL15
Icon of a box with the number 4 and a clock icon.



Jungle CS bowl & lid
Bol jungle CS & couvercle
Dschungelschale CS & Deckel
Bol jungle CS & tapa
Zuppiera Jungle con manici & coperchio
NAJB57 57 cl / 19 1/4 oz
Icon of a box with the number 4.

Lid for jungle CS bowl
Couvercle
bol jungle CS
Deckel für
Dschungelschale CS
Tapa para bol jungle CS
Coperchio per zuppiera
Jungle con manici
NALD01
Icon of a box with the number 4.

CUPS AND BOWLS
TASSES ET BOLS
TASSEN UND SCHALEN
TAZAS Y BOLS
TAZZE E COPPETTE



Noodle bowl
Bol à nouilles
Nudelschale
Noodle Bol
Coppetta per pasta
OPNB15 15 cm - 6 cm - 63 cl
6" - 2 1/3" - 21 2/7 oz
Icon of a box with the number 6.



Round bowl Katori
Bol rond Katori
Schale rund Katori
Bol redondo Katori
Coppetta rotonda Katori
MNRD10 10 cm - 4.5 cm - 18 cl
4" - 1 3/4" - 6 oz
Icon of a box with the number 12.



Stackable salad bowl
Saladier empilable
Salatschale stapelbar
Ensaladera apilable
Insalatiera impilabile
OPBW10 11 cm - 5 cm - 23.5 cl
4 1/5" - 1 6/7" - 8 1/4 oz
OPBW09 9 cm - 4 cm - 12 cl
3 1/2" - 1 1/2" - 4 2/9 oz
OPBW07 7.5 cm - 3.5 cm - 7 cl
3" - 1 3/8" - 2 1/2 oz
Icon of a box with the number 12 and a clock icon.



Round stackable dish
Ravier rond empilable
Schale rund stapelbar
Bol redondo apilable
Coppetta rotonda impilabile
OPBW06 6 cm - 2.5 cm - 3 cl
2 1/3" - 1" - 1 oz
Icon of a box with the number 12 and a clock icon.



Cup
Tasse
Tasse
Taza
Tazza
OPCU15 15 cl / 5 oz
Icon of a box with the number 12 and a clock icon.



Stackable mug Casino
Chope Casino empilable
Becher Casino stapelbar
Mug Casino apilable
Mug Casino impilabile
OPCM23 23 cl / 7 7/9 oz
Icon of a box with the number 12.



Stackable mug Baltic
Chope Baltic empilable
Becher Baltic stapelbar
Mug Baltic apilable
Mug Baltic impilabile
OPBMG23 23 cl / 7 7/9 oz
Icon of a box with the number 12.



Mug Ambrosia
Chope Ambrosia
Becher Ambrosia
Mug Ambrosia
Mug Ambrosia
ACAM35 35 cl / 11 5/6 oz
ACAM25 25 cl / 8 4/9 oz
Icon of a box with the number 12.



Mug Sunshine
Chope Sunshine
Becher Sunshine
Mug Sunshine
Mug Sunshine
OPSMG33 8 cm - 33 cl
3 1/7" - 11 1/6 oz
OPMG28 8 cm - 28 cl
3 2/9" - 9 6/7 oz
Icon of a box with the number 12 and a clock icon.
OPSMG24 7.5 cm - 24 cl
3" - 8 1/9 oz
Icon of a box with the number 12.
OPSMG18 6.5 cm - 18 cl
2 5/9" - 6 oz
OPSMG09 5 cm - 9 cl
2" - 3 oz
Icon of a box with the number 12 and a clock icon.



ACCESSORIES
ACCESSOIRES
ZUBEHÖR
ACCESORIOS
ACCESSORI

Square fruit bowl
Coupelle carrée
Schälchen quadratisch
Bol frutero cuadrado
Fruttiera quadrata
OPFB10 10 cm - 18 cl
4" - 6 oz
Icon of a box with the number 12 and a clock icon.



Sauce cup & lid
Moutardier & couvercle
Senftopf & Deckel
Salsera & tapa
Salsiera & coperchio
OPCU12 7 cm - 6.5 cm - 12 cl
2 3/4" - 2 5/9" - 4 oz
Icon of a box with the number 12.

Lid for sauce cup
Couvercle pour moutardier
Deckel für Senftopf
Tapa para salsera
Coperchio per salsiera
OPLD01
Icon of a box with the number 12.



Spoon for sauce cup
Cuillère pour moutardier
Löffel für Senftopf
Cuchara para salsera
Cucchiaio per salsiera
OPSP12 12 cm / 4 5/7"
Icon of a box with the number 12.



Sauce bottle & lid
Saucière & couvercle
Saucenkännchen & Deckel
Salsera & tapa
Salsiera & coperchio
ACSY01 9 cm - 11 cl
3 1/2" - 3 5/7 oz
Icon of a box with the number 12.

Lid for sauce bottle
Couvercle pour saucière
Deckel für Saucenkännchen
Tapa para salsera
Coperchio per salsiera
ACSYLD01
Icon of a box with the number 24.



Magic oil/vinegar
Huillier/vinaigrier
Öl/Essigkanne
Aceitera/vinagrero
Bricco da olio/aceto

ACOV01 20 cl / 6 3/4 oz
12

Lid for vinegar pot
Couvercle pour vinaigrier
Deckel für Essigkanne
Tapa para vinagrero
Coperchio per bricco da aceto

ACOVLD
24



Yin Yang saucer
Yin Yang saucière
Yin Yang Sauciere
Salsera Yin Yang
Salsiera Yin Yang

ACYY01 10 cm / 4"
24



Golfball pepper shaker
Poivrier golf
Pfefferstreuer Golf
Pimentero pelota golf
Pepiera palla golf

OPGB01 4 x 4 cm
1 4/7 x 1 4/7"
6



Golfball salt shaker
Salière golf
Salzstreuer Golf
Salero pelota golf
Saliera palla golf

OPGB02 4 x 4 cm
1 4/7 x 1 4/7"
6



Pepper shaker
Poivrier
Pfefferstreuer
Pimentero
Pepiera

OPPS01 5.5 x 2.5 cm - 4 cm
2 1/6 x 1" - 1 4/7"
12



Salt shaker
Salière
Salzstreuer
Salero
Saliera

OPSS01 5.5 x 2.5 cm - 4 cm
2 1/6 x 1" - 1 4/7"
12



Soup spoon
Cuillère à soupe
Suppenlöffel
Cuchara de sopa
Cucchiaio da tavola

ACSP01 12 cm / 4 5/7"
24



Stand for spoon
Reposoir à cuillère
Stand für Löffel
Reposa cucharas
Porta cucchiaio

ACSS01 11.5 x 5.5 cm
4 1/2 x 2 1/6"
6



Chopstick holder
Porte-baguettes
Stäbchenhalter
Reposa palillos
Portabacchette

ACCS01 6 x 2 cm / 2 1/3 x 4/5"
24

**MINIATURES
MINIATURES
MINIATUREN
MINIATURAS
MINIATURE**



High cube
Cube haut
Kubus hoch
Cubo alto
Coppetta a cubo alta

OPSD01 5 cm - 5.5 cm - 9 cl
2" - 2 1/6" - 3 oz
12

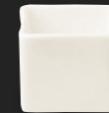

Small cube
Cube bas
Kubus klein
Cubo bajo
Coppetta a cubo piccola

OPSD02 5 cm - 4.5 cm - 6 cl
2" - 1 7/8" - 2 oz
12



Square creamer/gravy boat
Crémier/saucière carré
Saucière/Milchkännchen quadratisch
Salsera/lechera cuadrada
Salsiera/bricco da latte quadrato

OPSD03 5 cm - 6 cm - 8 cl
2" - 2 2/7" - 2 4/5 oz
12



Mini pan with grip
Mini poêlon avec poignée
Mini Pfanne mit Griff
Mini sartén con asa
Mini tegame

MNMP01 6.2 cm / 2 4/9"
12



Square sauce dish
Bol à sauce carré
Saucenschale quadratisch
Bol salsa cuadrado
Salsiera quadrata

ACSD01 7.5 cm - 3 cm
3" - 1 1/6"
6



Rectangular Twin sauce bowl
Coupelle à sauce double
Doppelte Saucenschale
rechteckig
Bol salsa doble rectangular
Coppetta per salsa doppia rettangolare

ACTS01 14.5 x 7 cm - 3 cm
5 5/7 x 2 3/4" - 1 1/6"
6



Mini boat bowl
Mini bol bateau
Mini Bootschale
Mini bol barco
Mini coppetta barca

MNOD05 7.5 x 4.5 cm - 3 cm - 3 cl
2 7/8 x 1 7/8" - 1 1/6" - 1 oz
6



Miniature triangular boat
Miniature bateau triangulaire
Miniatur Boot dreieckig
Miniatura barco triangular
Miniatura barca triangolare

MNTD01 7.5 x 6 cm - 3 cm
3 x 2 1/3" - 1 1/6"
6



Miniature square boat
Miniature bateau carré
Miniatur Boot quadratisch
Miniatura barco cuadrado
Miniatura barca quadrata

MNSD01 6 cm - 3 cm - 6 cl
2 1/3" - 1 1/6" - 2 oz



Ramekin with grooves
Ramequin plissé
Auflaufform gerillt
Ramequin estriado
Stampo scanalato

ACRG10 10 cm - 33 cl
4" - 11 1/6 oz

ACRG09 9 cm - 19 cl
3 1/2" - 6 3/7 oz



Triangular plate, 3 compartments
Plat triangulaire, 3 compartiments
Platte dreieckig, 3 Vertiefungen
Bandeja triangular, 3 compartimentos
Piatto triangolare, 3 compartimenti

ACTR01 30 x 26 cm
11 2/3 x 10 1/5



Asymmetric dish
Coupelle asymétrique
Schale asymmetrisch
Bol asimétrico
Coppetta asimmetrica

OPAB06 6 cm - 2 cm
2 1/3" - 4/5"

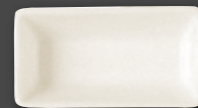

Rectangular dish
Ravier rectangulaire
Schale rechteckig
Platillo rectangular
Coppetta rettangolare

ACRD10 10 x 6 cm / 4 x 2 2/7"



Butterfly dish
Plat papillon
Schmetterlingsschale
Plato mariposa
Coppetta di farfalla

NABD16 17 x 13 cm
6 2/3 x 5"



Trio dish
Coupelle triple
Triple Schale
Rabanera triple
Coppetta tripla

MNTR01 15 x 14.5 cm
6 x 5 3/4"



Glove dish
Coupelle
Schale
Rabanera
Coppetta

MNGD01 13 x 12 cm
5 1/5 x 4 5/7"



Miniature round bowl
Miniature bol rond
Miniaturschale rund
Miniatura bol redondo
Miniatura coppetta rotonda

OPCU05 5 cl / 1 2/3 oz



Moon plate
Plateau lune
Mondplatte
Plato luna
Piatto luna

OPMP01 21 x 12 cm
8 2/9 x 4 5/7"



Egg cup
Coquetier
Eierbecher
Huevera
Portauovo

OPEG01



Creamer
Crémier
Milchkännchen
Lechera
Bricco da latte

OPCR09M 6 cm - 7.2 cm - 9 cl
2 1/3" - 2 5/6" - 3 1/6 oz



Square bowl
Bol carré
Schale quadratisch
Bol cuadrado
Coppetta quadrata

OPSB04 4 cm / 1 4/7"



Jigsaw plate
Plat Jigsaw
Platte Jigsaw
Fuente Jigsaw
Piatto Jigsaw

OPJP20 20 x 15 cm
8 x 6"



Jigsaw bowl
Bol Jigsaw
Schale Jigsaw
Bol Jigsaw
Coppetta Jigsaw

OPJB18 12.5 x 9 cm - 18 cl
4 7/8 x 3 2/3" - 6 1/3 oz



Halo dish
Ravier Halo
Schale Halo
Rabanera Halo
Coppetta Halo

MNHD01 13 x 10 cm
5 1/5 x 4"



Sauce dish, 4 indents
Ravier sauce, 4 empreintes
Schale, 4 Ringe
Platillo, 4 estanques
Salsiera, 4 inserti

MNID04 13.5 x 11 cm
5 1/3 x 4 1/5"



Lemon dish
Ravier citron
Zitronenschale
Platillo limon
Piatto limone

MNLN01 13.5 x 8 cm
5 1/3 x 3 1/5"



Pieces per box
 Pièces par boîte
 Stück pro Karton
 Piezas por caja
 Pezzi per scatola

Extra time for deliveries
 Délai supplémentaire
 Zusätzliche Lieferzeit
 Período de abastecimiento adicional
 Termine di consegna supplementare

En

Inspired by nature, NABUR reveals sculptural, organic-curved shapes. Like a paean to difference, shapes and materials, NABUR celebrates the boldness of leading chefs.

Fr

Inspirée de la nature, NABUR révèle des formes sculpturales aux courbes organiques. Ode à la différence, aux formes et à la matière, NABUR célèbre l'audace des plus grands chefs.

De

Von der Natur inspiriert, fällt die Kollektion NABUR durch bildhauerische Formen und organisch geformte Linien auf. NABUR ist eine Ode an die Vielfalt der Formen und Materialien und eine Reminiszenz an die Kühnheit der großen Meisterköche.

Es

NABUR, inspirada en la naturaleza, revela formas esculturales con curvas orgánicas. Como en una oda a la diferencia, a las formas y a la materia, NABUR elogia la audacia de los mejores chefs.

It

Ispirata alla natura, la linea NABUR sfoggia forme scultoree dalle curve organiche. Vera e propria ode alla diversità, alle forme e alla materia, NABUR celebra l'audacia dei migliori chef.

DESIGN BY MIKAELA DOERFEL





Dinner plate, 2 basins
Assiette, 2 bassins
Teller, 2 Vertiefungen
Plato, 2 zonas
Piatto, 2 inserti

NBFP32 32 x 26.5 cm
12 3/5 x 10 3/7"



Bowl
Bol
Schale
Bol
Coppetta

NBSB23 23 x 19.5 cm - 6.5 cm - 77 cl
9 x 7 2/3" - 2 1/2" - 26 oz

NBSB19 19 x 16 cm - 5.8 cm - 61 cl
7 1/2 x 6 2/9" - 2 2/7" - 20 5/8 oz

NBSB16 16 x 13 cm - 5 cm - 30 cl
6 2/7 x 5 1/8" - 2" - 10 oz



Dinner coupe plate
Assiette coupe
Teller coupe
Plato coupe
Piatto senza falda

NBFP31 31 x 26.5 cm
12 1/5 x 10 3/7"



NBFP27 27 x 22.5 cm
10 5/8 x 8 6/7"



Dip bowl
Coupelle
Schälchen
Bol hondo
Coppetta

NBDB08 8 x 6.5 cm - 2 cm - 4 cl
3 1/7 x 2 5/9" - 4/5" - 1 1/3 oz



Breakfast plate, 2 basins
Assiette, 2 bassins
Teller, 2 Vertiefungen
Plato desayuno, 2 zonas
Piatto, 2 inserti

NBFP24 > NBCU26
24 x 20 cm
9 4/9 x 7 7/8"



Sauce boat/creamer
Saucière/crémier
Sauciere/Milchkännchen
Salsera/lechera
Salsiera/bricco da latte

NBCR25 14 x 10 cm - 4.5 cm - 25 cl
5 1/2 x 3 6/7" - 1 7/9" - 8 4/9 oz



NBCR15 12.5 x 8.5 cm - 4 cm - 15 cl
5 x 3 1/3" - 1 4/9" - 5 oz

NBCR06 9 x 6.5 cm - 4 cm - 6 cl
3 5/8 x 2 1/2" - 1 4/9" - 2 oz



Party plate
Assiette cocktail
Cocktailteller
Plato cóctel
Piatto cocktail

NBPP22 22 x 15.5 cm
8 2/3 x 6 1/9"



Breakfast cup
Tasse à déjeuner
Frühstückstasse
Taza de desayuno
Tazza da colazione

NBCU34 9 cm - 34 cl
3 3/7" - 11 1/2 oz



Espresso cup
Tasse à espresso
Espressotasse
Taza a expreso
Tazza da espresso

NBCU09 6 cm - 9 cl
2 1/3" - 3 oz



Coffee/tea cup
Tasse à café/thé
Kaffee-/Teetasse
Taza a café/té
Tazza da caffè/tè

NBCU26 9 cm - 26 cl
3 3/7" - 8 4/5 oz



Saucer for espresso cup
Soucoupe pour tasse à espresso
Untere für Espressotasse
Platillo para taza a expreso
Piattino per tazza da espresso

NBSA15 > NBCU09
15 x 12.5 cm / 6 x 5"



Saucer for breakfast cup and coffee/tea cup
Soucoupe pour tasse à déjeuner et tasse à café/thé
Untere für Frühstückstasse und für Tee/Kaffeetasse
Platillo para taza de desayuno y taza café/té
Piattino per Tazza da colazione e da caffè/tè

NBSA18 > NBCU34 / NBCU26
16 x 13.5 cm / 6 2/7 x 5 1/4"



Teapot & lid
Théière & couvercle
Teekanne & Deckel
Tetera & tapa
Teiera & coperchio

NBTP80 80 cl / 27 oz



Lid for teapot
Couvercle pour théière
Deckel für Teekanne
Tapa para tetera
Coperchio per teiera

NBTPLD2



Coffee pot & lid
Cafetière & couvercle
Kaffeekanne & Deckel
Cafetera & tapa
Caffettiera & coperchio

NBCP50 50 cl / 17 oz



Lid for coffee pot
Couvercle pour cafetière
Deckel für Kaffeekanne
Tapa para cafetera
Coperchio per caffettiera

NBCPLD1



Pieces per box
Pièces par boîte
Stück pro Karton
Piezas por caja
Pezzi per scatola

En

NANO's lines are exquisitely pure displaying a traditional Asian charm. This collection's pared-down style means it can be adapted for different dishes and uses.

Fr

Avec un charme traditionnel venu d'Asie, NANO présente des lignes d'une exquise pureté. Son style dépouillé permet à cette collection de s'adapter à des plats et des usages variés.

De

Mit ihrer klaren Linienführung vermittelt die Kollektion NANO traditionellen asiatischen Charme. Durch die nüchterne Gestaltung kann die Kollektion für zahlreiche Gerichte und Einsatzbereiche verwendet werden.

Es

Con un encanto venido desde Asia, NANO presenta líneas de exquisita pureza. Su estilo austero permite que esta colección se adapte a una amplia variedad de platos y usos.

It

Con il suo fascino tradizionale di derivazione asiatica, NANO presenta delle linee dalla purezza semplicemente squisita. Il suo stile essenziale consente a questa collezione di adattarsi a piatti e usi di ogni tipo.





Rectangular serving plate

Assiette à servir
rectangulaire
Servierteller rechteckig
Plato para servir
rectangular
Piatto da portata
rettangolare

EDRG33IV 33.5 x 18 cm
13 1/5 x 7 1/8"

12



Coupe bowl

Bol coupe
Schale coupe
Bol coupe
Coppetta senza falda

BUBC30 30 cm - 190 cl
11 4/5" - 64 1/4 oz

6

BUBC26 26 cm - 120 cl
10 1/4" - 1 4/7" - 40 4/7 oz

12



Rice bowl

Bol à riz
Reisschale
Bol arroz
Coppetta per riso

NNRB16 16 cm - 6.5 cm - 58 cl
6 2/7" - 2 5/9" - 19 3/5 oz

12



Bowl & lid

Bol & couvercle
Schale & Deckel
Bol & tapa
Coppetta & coperchio

NNCU17 9 cm - 9.5 cm - 17 cl
3 1/2" - 3 3/4" - 5 3/4 oz

12



Square plate

Assiette carrée
Teller quadratisch
Plato cuadrado
Piatto quadrato

EDSQ30IV 30 cm / 11 8/9"

6

EDSQ27IV 27 cm / 10 5/8"

EDSQ25IV 24.5 cm / 9 2/3"

12



Butter dish

Assiette à beurre
Butterschale
Plato mantequilla
Piatto da burro

NNBD09 9 cm / 3 1/2"

NNBD07 7 cm / 2 3/4"

12



Cream soup bowl & lid

Bol à bouillon & couvercle
Suppentasse & Deckel
Bol consommé & tapa
Scodella per zuppa & coperchio

NNCS27 12 cm - 11 cm - 27 cl
4 5/7" - 4 1/3" - 9 1/8 oz

6



Saucer for bowl

Soucoupe pour bol
Untere für Schale
Platillo para bol
Piatto per coppetta

NNSA10 10 cm / 4"

12



Salad bowl

Saladier
Salatschale
Ensaladera
Insalatiera

EDSB70IV 20 cm - 7 cm - 140 cl
7 7/8" - 2 4/5" - 47 1/3 oz

EDSB45IV 20 cm - 6 cm - 100 cl
7 7/8" - 2 2/7" - 33 4/5 oz

12



Oval platter

Plat ovale
Platte oval
Fuente oval
Piatto ovale

NNOP36 36 x 27 cm / 14 1/16 x 10 5/8"

NNOP32 32 x 23 cm / 12 3/5 x 9"

6

NNOP26 26 x 19 cm / 10 1/4 x 7 1/2"

NNOP21 21 x 15 cm / 8 1/4 x 6"

12



Saucer for soup bowl

Soucoupe pour bol à bouillon
Untere für Suppentasse
Platillo para bol consommé
Piatto per scodella per zuppa

NNST16 16 cm / 6 2/7"

12



Teapot & lid

Théière & couvercle
Teekanne & Deckel
Tetera & tapa
Teiera & coperchio

NNTP110 110 cl / 37 1/5 oz

NNTP40 40 cl / 13 1/2 oz

4



Lid for teapot

Couvercle pour théière
Deckel für Teekanne
Tapa para tetera
Coperchio per teiera

NNTPLD2 > NNTP110

NNTPLD1 > NNTP40

12



Flat coupe plate

Assiette coupe plate
Teller flach coupe
Plato llano coupe
Piatto piano senza falda

NNPR31 31 cm / 12 1/5"

6

NNPR27 27 cm / 10 5/8"

NNPR24 24 cm / 9 4/9"

NNPR21 21 cm / 8 1/4"

12

NNPR18 18 cm / 7"

NNPR15 15 cm / 6"

24



Cereal bowl

Bol à céréales
Muesli-Schale
Bol a cereales
Coppetta per cereali

NNBW20 20 cm - 6 cm - 90 cl
7 7/8" - 2 2/7" - 30 3/7 oz

6



Non stackable bowl

Bol non empilable
Schale nicht stapelbar
Bol no apilable
Coppetta non impilabile

NNBW12 12 cm - 5.5 cm - 27 cl
4 5/7" - 2 1/6" - 9 1/8 oz

NNBW10 10 cm - 5 cm - 16 cl
4" - 2" - 5 2/5 oz

NNBW09 9 cm - 4 cm - 11 cl
3 1/2" - 1 4/7" - 3 5/7 oz

12



Creamer

Crémier
Milchkännchen
Lechera
Bricco da latte

NNCR15 15 cl / 5 oz

6



Sugar bowl & lid
Sucrier & couvercle
Zuckerdose & Deckel
Azucarero & tapa
Zuccheriera & coperchio
NNSU25 25 cl / 8.4/9 oz
📦 6

Lid for sugar bowl
Couvercle pour sucrier
Deckel für Zuckerdose
Tapa para azucarero
Coperchio per zuccheriera
NNSULD
📦 12

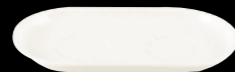

Oil/vinegar/soja sauce pot stand
Support à huilier/vinaigrier/pot à sauce soja
Platte für Öl/Essig/Sojasoße
Platillo para aceitera/vinagrera/salsa soja
Vassoio per bricco da olio/aceto/salsa di soia
NNST19 19 x 11 cm
7 1/2 x 4 1/3"
📦 12



Spoon
Cuillère
Löffel
Cuchara
Cucchiaio
NNSP15 15 cm / 6"
📦 12 🕒
NNSP14 14 cm / 5 1/2"
📦 12



Spoon/chopstick holder
Cuillère/repose baguettes
Löffel/Stäbchenhalter
Cuchara/soporte palillos
Cucchiaio/portabacchette
NNST07 7 cm / 2 3/4"
📦 12 🕒



Double cubicle dish
Plat à sauce,
2 compartiments
Doppelsaucenschale
Plato a salsa rectangular,
2 compartimentos
Ciotola per salse,
2 compartimenti
NNCD02 9 cm / 3 1/2"
📦 12



Oil/vinegar/sauce soja pot
Huilier/vinaigrier/
pot à sauce soja
Kanne für Öl/Essig/
Sojasoße
Aceitera/vinagrera/
jarra a salsa soja
Bricco da olio/aceto/
salsa di soia
NNOV12 12 cl / 4 oz
📦 12



Wine cup
Coupe à vin
Weinbecher
Copa de vino
Tazza da vino
NNWC01 5.5 cm - 1.2 dl
2 1/6" - 2/5 oz
📦 6 🕒

Lid for vinegar pot
Couvercle pour vinaigrier
Deckel für Essigkanne
Tapa para vinagrero
Coperchio per bricco da aceto
NNOVLD
📦 12

📦 Pieces per box
Pièces par boîte
Stück pro Karton
Piezas por caja
Pezzi per scatola

🕒 Extra time for deliveries
Délai supplémentaire
Zusätzliche Lieferzeit
Período de abastecimiento adicional
Termine di consegna supplementare



En

NORDIC's rectilinear silhouette and minimalist simplicity give it characteristic style. Designed specifically for professionals, NORDIC is easily stackable. All of its items have been designed to be infinitely modular.

Fr

NORDIC possède un style caractéristique avec une silhouette rectiligne d'une sobriété minimaliste. Spécialement conçue pour les professionnels, NORDIC s'empile à merveille. Chacune de ses pièces est pensée pour être modulable à l'infini.

De

NORDIC besitzt einen charakteristischen Stil mit einer geradlinigen Silhouette und minimalistischer Zurückhaltung. Die Kollektion wurde speziell für den professionellen Bereich entworfen und lässt sich wunderbar stapeln. Jedes einzelne Teil ist so konzipiert, dass es uneingeschränkt modular eingesetzt werden kann.

Es

NORDIC posee un estilo característico con una silueta rectilínea de una sobriedad minimalista. NORDIC, especialmente concebida para los profesionales, se apila maravillosamente. Cada una de sus piezas está pensada para poder ser modulable hasta el infinito.

It

La collezione NORDIC presenta uno stile caratteristico con una silhouette che predilige linee rette, sobrie e minimaliste. Appositamente concepita per i professionisti, NORDIC si impila a meraviglia. Ogni pezzo è stato pensato per essere modulabile all'infinito.





Flat plate with rim
Assiette plate à aile
Teller flach mit Rand
Plato llano con ala
Piatto piano con falda

NOFP32 32 cm / 12 3/5"
NOFP28 28 cm / 11"
NOFP24 24 cm / 9 4/9"
6



Rimless flat plate/lid
Assiette plate sans aile/
couvercle
Teller flach ohne Rand/
Deckel
Plato llano sin ala/tapa
Piatto piano senza falda/
coperchio

NOLD23 > NODP23
23 cm / 9"
6
NOLD20 > NODP20
20 cm / 7 7/8"
NOLD16 > NOBW16
16 cm / 6 2/7"
NOLD14 > NOBW14
14 cm / 5 1/2"
NOLD12 > NOBW12
12 cm / 4 5/7"
12



Deep plate
Assiette creuse
Teller tief
Plato hondo
Piatto fondo

NODP23 > NOFP32
23 cm / 9"
NODP20 > NOFP28
20 cm / 7 7/8"
6



Mini plate with rim
Mini assiette à aile
Miniteller mit Rand
Mini plato con borde
Mini piatto con falda

NOBD01 6 cm / 2 1/3"
12



Bowl
Bol
Schale
Bol
Coppetta

NOBW16 16 cm - 7 cm - 100 cl
6 2/7" - 2 3/4" - 33 4/5 oz
6
NOBW14 14 cm - 6 cm - 68 cl
5 1/2" - 2 1/3" - 23 oz
NOBW12 12 cm - 5 cm - 48 cl
4 5/7" - 2" - 16 2/9 oz
12



Mise en bouche/cup
Mise en bouche/tasse
Mise en bouche/Tasse
Mise en bouche/taza
Mise en bouche/tazza

NOMB1 9 cl / 3 oz
12



Breakfast cup
Tasse à déjeuner
Frühstückstasse
Taza de desayuno
Tazza da colazione

NOCU30 30 cl / 10 1/7 oz
6



Saucer for Breakfast/tea cup
Soucoupe pour tasse à déjeuner/thé
Untere für Frühstücks/Teetasse
Platillo para taza a desayuno/té
Piattino per tazza da colazione/té

NOSA3 > NOCU30
15.5 cm / 6 1/9"
6



Tea cup
Tasse à thé
Teetasse
Taza a té
Tazza da tè

NOCU23 23 cl / 7 7/9 oz
12



Saucer for Breakfast/tea cup
Soucoupe pour tasse à déjeuner/thé
Untere für Frühstücks/Teetasse
Platillo para taza a desayuno/té
Piattino per tazza da colazione/té

NOSA3 > NOCU23
15.5 cm / 6 1/9"
6



Coffee cup
Tasse à café
Kaffeetasse
Taza a café
Tazza da caffè

NOCU20 20 cl / 6 3/4 oz
12



Saucer for coffee cup
Soucoupe pour tasse à café
Untere für Kaffeetasse
Platillo para taza a café
Piattino per tazza da caffè

NOSA2 > NOCU20
14 cm / 2"
6



Espresso cup
Tasse à espresso
Espressotasse
Taza a expreso
Tazza da espresso

NOCU09 9 cl / 3 oz
12



Saucer for espresso cup
Soucoupe pour tasse à espresso
Untere für Espressotasse
Platillo para taza a expreso
Piattino per tazza da espresso

NOSA1 > NOCU09
10 cm / 4"
12



Mug
Chope
Becher
Mug
Mug

NOMG33 33 cl / 11 1/6 oz
6





Coffee pot & lid
Cafetière & couvercle
Kaffeekanne & Deckel
Cafetera & tapa
Caffettiera & coperchio
NOCP100 100 cl / 33 4/5 oz
NOCP40 40 cl / 13 1/2 oz
4



Creamer
Crémier
Milchkännchen
Lechera
Bricco da latte
NOCR50 50 cl / 17 oz
NOCR15 15 cl / 5 oz
6

Lid for coffee pot
Couvercle pour cafetière
Deckel für Kaffeekanne
Tapa para cafetera
Coperchio per caffettiera
NOCPD2 > NOCP100
NOCPD1 > NOCP40
12



Pepper shaker
Poivrier
Pfefferstreuer
Pimentero
Pepiera
NOPS01
12



Salt shaker
Salière
Salzstreuer
Salero
Saliera
NOSS01
12



Teapot & Lid
Théière & couvercle
Teekanne & Deckel
Tetera & tapa
Teiera & coperchio
NOTP100 100 cl / 33 4/5 oz
NOTP40 40 cl / 13 1/2 oz
4

Lid for teapot
Couvercle pour théière
Deckel für Teekanne
Tapa para tetera
Coperchio per teiera
NOTPLD2 > NOTP100
NOTPLD1 > NOTP40
12

4 Pieces per box
Pièces par boîte
Stück pro Karton
Piezas por caja
Pezzi per scatola



En

PIXEL displays a relief decoration that is inviting to the touch. Tough and original, its pattern reflects the light for an exquisite dining experience.

Fr

PIXEL affiche un décor en relief qui invite au toucher. Robuste et original, son ornement réfléchit la lumière pour une expérience gustative exquise.

De

Die Kollektion PIXEL lädt mit ihrem Relief-Dekor förmlich dazu ein, ertastet zu werden. Robust und originell zugleich wirkt sich die Verzierung auf die Lichtwahrnehmung und die geschmackliche Sensorik aus.

Es

PIXEL hace alarde de una decoración en relieve que invita a tocar sus formas. Robusto y original, su ornamentación refleja la luz para crear una experiencia gustativa exquisita.

It

PIXEL sfoggia una decorazione in rilievo che invita al tocco. Robusto e originale, il suo motivo riflette la luce per una squisita esperienza gustativa.





Flat plate
Assiette plate
Teller flach
Plato llano
Piatto piano
PXFP32 32 cm / 12 3/5"
6
PXFP29 29 cm / 11 3/7"
PXFP27 27 cm / 10 5/8"
PXFP24 24 cm / 9 4/9"
PXFP21 21 cm / 8 1/4"
12
PXFP17 17 cm / 6 2/3"
24



**Cream soup bowl,
2 handles**
Tasse à bouillon, 2 anses
Suppentasse, 2 Henkel
Bol consommé, 2 asas
Scodella per zuppa,
2 manici
PXCS35 11.5 cm - 6.5 cm - 35 cl
4 1/2" - 2 3/5" - 11 5/6 oz
12



Cup
Tasse
Tasse
Taza
Tazza
PXC22 22 cl / 7 3/7 oz
12



Teapot & lid
Théière & couvercle
Teekanne & Deckel
Tetera & tapa
Teiera & coperchio
PXTP40 40 cl / 13 1/2 oz
4



Deep plate
Assiette creuse
Teller tief
Plato hondo
Piatto fondo
PXDP28 28 cm / 11"
PXDP24 24 cm / 9 4/9"
12



Cream soup bowl
Tasse à bouillon
Suppentasse
Bol consommé
Scodella per zuppa
PXCS01 11.5 cm - 6.5 cm - 35 cl
4 4/7" - 2 5/9" - 12 1/3 oz
12



Saucer
Soucoupe
Untere
Platillo
Piattino
PXSA15 > PXC22
15 cm / 6"
12

Lid for teapot
Couvercle pour théière
Deckel für Teekanne
Tapa para tetera
Coperchio per teiera
PXTP40LD
12



Oval plate
Plat ovale
Platte oval
Fuente oval
Piatto ovale
PXOP36 36 cm / 14 1/6"
PXOP34 34 cm / 13 2/5"
6



Cup
Tasse
Tasse
Taza
Tazza
PXC35 35 cl / 11 5/6 oz
12
PXC30 30 cl / 10 1/7 oz
12
PXC27 27 cl / 9 1/8 oz
12



Cup
Tasse
Tasse
Taza
Tazza
PXC09 9 cl / 3 oz
12



Coffee pot & lid
Cafetière & couvercle
Kaffeekanne & Deckel
Cafetera & tapa
Caffettiera & coperchio
PXC35 35 cl / 11 5/6 oz
4



Saucer
Soucoupe
Untere
Platillo
Piattino
PXSA17 > PXC35 / PXC30 / PXC27 /
PXCS01 / PXCS35
17 cm / 6 2/3"
12



Saucer
Soucoupe
Untere
Platillo
Piattino
PXSA12 > PXC09
12 cm / 4 5/7"
12

Lid for coffee pot
Couvercle pour cafetière
Deckel für Kaffeekanne
Tapa para cafetera
Coperchio per caffettiera
PXCPLD
12



Cereal bowl
Bol à céréales
Muesli-Schale
Bol a cereales
Coppetta per cereali
PXBC30 13.5 cm - 5.5 cm - 30 cl
5 1/3" - 2 1/6" - 10 1/7 oz
12



6 Pieces per box
Pièces par boîte
Stück pro Karton
Piezas por caja
Pezzi per scatola

12 Extra time for deliveries
Délai supplémentaire
Zusätzliche Lieferzeit
Período de abastecimiento adicional
Termine di consegna supplementare



Creamer
Crémier
Milchkännchen
Lechera
Bricco da latte

PXCR25 25 cl / 8 4/5 oz



PXCR15 15 cl / 5 oz



Salt shaker
Salière
Salzstreuer
Salero
Saliera

PXSS01



Pepper shaker
Poivrier
Pfefferstreuer
Pimentero
Pepiera

PXPS01



Ashtray
Cendrier
Ascher
Cenicero
Portacenere

PXAT01



Flower vase
Vase
Vase
Florero
Vaso

PXFV01 9 cm / 3 1/2"



 Pieces per box
Pièces par boîte
Stück pro Karton
Piezas por caja
Pezzi per scatola

 Extra time for deliveries
Délai supplémentaire
Zusätzliche Lieferzeit
Período de abastecimiento adicional
Termine di consegna supplementare



Sugar bowl & lid
Sucrier & couvercle
Zuckerdose & Deckel
Azucarero & tapa
Zuccheriera & coperchio

PXSU25 25 cl / 8 4/9 oz



Lid for sugar bowl

Couvercle pour sucrier
Deckel für Zuckerdose
Tapa para azucarero
Coperchio per zuccheriera

PXSULD



Candle holder
Bougeoir
Kerzenhalter
Porta velas
Portacandela

PXCH01



Toothpick holder
Porte cure-dents
Zahnstocherhalter
Palillero
Portastecchini

PXTH01



Egg Cup
Coquetier
Eierbecher
Huevera
Portauovo

PXEG01



Gravy boat
Saucière
Sauciere
Salsera
Salsiera

PXGB28 15 x 8.7 cm - 28 cl
6 x 3 3/7" - 9 6/7 oz



Saucer for gravy boat
Soucoupe pour saucière
Untere für Sauciere
Patillo para salsera
Piattino per salsiera

PXST01 > PXGB28

22 x 15.5 cm
8 5/8 x 6 1/7"



En

The PLAYA product line is an invitation to exoticism and freedom. Dishes will stand out on a background of bright white porcelain, putting creativity to the forefront.

Fr

La gamme PLAYA vous invite à l'exotisme et à la liberté. Sur un fond de porcelaine d'un blanc éclatant, les plats sont mis en relief et la créativité mise en lumière.

De

Die Kollektion PLAYA weckt Assoziationen von Exotik und Freiheit. Auf einer Grundlage aus strahlend weißem Porzellan kommen die Gerichte und die Kreativität besonders gut zur Geltung.

Es

La gama PLAYA le invita al exotismo y a la libertad. Su fondo de porcelana de un blanco resplandeciente hace destacar los platos y la creatividad.

It

La gamma Playa invita all'esotismo e alla libertà. Su una base in porcellana di un bianco abbagliante, i vostri piatti verranno messi in risalto e la creatività sarà valorizzata.





Rectangular flat plate
Assiette plate rectangulaire
Teller flach rechteckig
Plato llano rectangular
Piatto piano rettangolare

PLRP38 38 x 21 cm / 15 x 8 1/4"

PLRP33 33 x 23 cm / 13 x 9"

6

PLRP29 29 x 12 cm / 11 3/7 x 4 5/7"

PLRP26 26 x 8 cm / 10 1/4 x 3 1/7"

PLRP23 23 x 7 cm / 9 x 2 3/4"

12



**Non stackable cup
(Classic Gourmet)**
Tasse non empilable
(Classic Gourmet)
Tasse nicht stapelbar
(Classic Gourmet)
Taza no apilable
(Classic Gourmet)
Tazza non impilabile
(Classic Gourmet)

CLCU28 28 cl / 9 1/2 oz

12



Saucer
Soucoupe
Untere
Platillo
Piattino

PLSA17 > CLCU28

17 cm / 6 2/3"

12



Square flat plate
Assiette plate carrée
Teller flach quadratisch
Plato llano cuadrado
Piatto piano quadrato

PLSP30 30 cm / 11 4/5"

6

PLSP27 27 cm / 10 5/8"

PLSP24 24 cm / 9 4/9"

12



**Non stackable cup
(Classic Gourmet)**
Tasse non empilable
(Classic Gourmet)
Tasse nicht stapelbar
(Classic Gourmet)
Taza no apilable
(Classic Gourmet)
Tazza non impilabile
(Classic Gourmet)

CLCU23 23 cl / 7 7/9 oz

CLCU20 20 cl / 6 3/4 oz

12



Saucer
Soucoupe
Untere
Platillo
Piattino

PLSA15 > CLCU23 / CLCU20

15 cm / 6"

12



Round flat plate
Assiette plate ronde
Teller flach rund
Plato llano redondo
Piatto piano rotondo

PLFP31 31 cm / 12 1/5"

6

PLFP29 29 cm / 11 3/7"

PLFP27 27 cm / 10 5/8"

PLFP24 24 cm / 9 4/9"

12

PLFP21 21 cm / 8 1/4"

PLFP17 17 cm / 6 2/3"

PLFP15 15 cm / 6"

24



Round deep plate
Assiette creuse ronde
Teller tief rund
Plato hondo redondo
Piatto piano rotondo

PLDP30 30 cm / 11 4/5"

6

PLDP24 24 cm / 9 4/9"

12



**Non stackable cup
(Classic Gourmet)**
Tasse non empilable
(Classic Gourmet)
Tasse nicht stapelbar
(Classic Gourmet)
Taza no apilable
(Classic Gourmet)
Tazza non impilabile
(Classic Gourmet)

CLCU09 9 cl / 3 oz

12



Saucer
Soucoupe
Untere
Platillo
Piattino

PLSA13 > CLCU09

13 cm / 5 1/8"

12



En

The quintessence of luxury, this divine collection is designed for high-end gastronomy. Thanks to its enamel coating, the gold decoration is guaranteed to be dishwasher-safe.

Fr

Quintessence du luxe, cette collection sert divinement la haute gastronomie. Réalisé sous-émail, la solidité du décor or est garanti pour le passage au lave-vaisselle.

De

Als Quintessenz des Luxus dient diese Kollektion in herrlicher Form der Spitzengastronomie. Hergestellt mit einer durch Glasur geschützten Golddekoration, ist die Beständigkeit auch bei Nutzung der Geschirrspülmaschine gesichert.

Es

La colección Quintaesencia del lujo sirve divinamente la alta gastronomía. Realizado con técnica de subesmaltado, la solidez de la decoración dorada permite que puedan lavarse en lavavajillas.

It

Quintessenza del lusso, questa collezione serve divinamente l'alta gastronomia. Realizzato in smalto, la solidità del decoro in oro è garantita per il passaggio in lavastoviglie.





KING

Serving tray rectangular

Plat rectangulaire
Platte rechteckig
Bandeja servicio rectangular
Vassoio da portata rettangolare

D5GDRT42 42 x 32 cm
16 1/2 x 12 4/5"

6



Square plate

Assiette carrée
Teller quadratisch
Plato cuadrado
Piatto quadrato

D5GDSP34 34 cm / 13 2/5"

6

D5GDSP26 26 cm / 10 1/4"

12



QUEEN

Round plate

Assiette ronde
Teller rund
Plato redondo
Piatto rotondo

D5GDRP31 31 cm / 12 1/5"

6



Round plate

Assiette ronde
Teller rund
Plato redondo
Piatto rotondo

D5GDRP22 22 cm / 8 2/3"

12

D5GDRP16 16 cm / 6 2/7"

24



PRINCE

Deep plate

Assiette creuse
Teller tief
Plato hondo
Piatto fondo

D5GDDP29 29 cm / 11 3/7"

D5GDDP23 23 cm / 9"

6



PRINCESS

Scallop plate

Assiette festonnée
Teller festoniert
Plato scallop
Piatto smerlato

D5GDSP33 33 cm / 13"

6



Soup tureen & lid

Soupière & couvercle
Suppenterrine & Deckel
Sopera & tapa
Zuppiera & coperchio

D5GDSB340 340 cl / 115 oz

1



Tea cup

Tasse à thé
Teetasse
Taza a té
Tazza da tè

D5GDCU21 21 cl / 7 oz

12



Bowl

Bol
Schale
Bol
Copetta

D5GDCU21M 21 cl / 7 oz

12



Saucer

Soucoupe
Untere
Platillo
Piattino

D5GDSA15 > D5GDCU21 / D5GDCU21M

15 cm / 6"

12



Espresso cup

Tasse à espresso
Espressotasse
Taza a expreso
Tazza da espresso

D5GDCU09 9 cl / 3 oz

12



Bowl

Bol
Schale
Bol
Copetta

D5GDCU09M 9 cl / 3 oz

12



Saucer

Soucoupe
Untere
Platillo
Piattino

D5GDSA12 > D5GDCU09 / D5GDCU09M

12 cm / 4 5/7"

12



Coffee pot & lid

Cafetière & couvercle
Kaffeekanne & Deckel
Cafetera & tapa
Caffettiera & coperchio

D5GDGP160 160 cl / 54 oz

4



Teapot & lid

Théière & couvercle
Teekanne & Deckel
Tetera & tapa
Teiera & coperchio

D5GDTP150 150 cl / 50 5/7 oz

4



Sugar bowl & lid

Sucrier & couvercle
Zuckerdose & Deckel
Azucarero & tapa
Zuccheriera & coperchio

D5GDSU25 25 cl / 8 4/9 oz

6



⌚ These items or collections are custom made, so please allow additional time for delivery.

Ces articles ou collections sont produits à la demande, prévoir un délai d'approvisionnement supplémentaire.

Diese Artikel oder Kollektionen werden entsprechend der Nachfrage hergestellt, eine zusätzliche Lieferzeit einplanen.

Estos artículos o colecciones se fabrican en función de la demanda. Debe fijarse un período de abastecimiento adicional.

Questi articoli o collezioni sono prodotti su richiesta, si prega di quindi di prevedere un termine di consegna supplementare.

📦 Pieces per box
Pièces par boîte
Stück pro Karton
Piezas por caja
Pezzi per scatola

En

With exquisite gentle, rounded lines, on dishes and flat plates, RONDO perfectly enhances your culinary creations. A hotel collection par excellence!

Fr

Avec d'exquises lignes arrondies tout en douceur, creuses ou plates, RONDO valorise les créations culinaires à merveille. La collection hôtelière par excellence!

De

Mit einer dezenten und runden, sanften Liniensprache stellt die Kollektion RONDO die kulinarischen Kreationen in den Mittelpunkt. Die Hotelkollektion par excellence!

Es

RONDO , con exquisitas y suaves líneas redondeadas, ahondadas o llanas, valoriza a la perfección las creaciones culinarias. ¡Es la colección hostelera por excelencia!

It

Con squisite linee morbide e arrotondate, i piatti fondi e piani della linea RONDO valorizzano al massimo le vostre creazioni culinarie. La collezione per il settore dell'ospitalità per eccellenza!





Flat plate

Assiette plate
Teller flach
Plato llano
Piatto piano

BAFP31D7 31 cm / 12 1/5"



BAFP29D7 29 cm / 11 3/7"

BAFP27D7 27 cm / 10 5/8"

BAFP24D7 24 cm / 9 4/9"



BAFP21D7 21 cm / 8 1/4"

BAFP19D7 19 cm / 7 1/2"

BAFP17D7 17 cm / 6 2/3"

BAFP15D7 15 cm / 6"



**Cream soup bowl
2 handles**

Tasse à bouillon,
2 anses
Suppentasse,
2 Henkel
Bol consommé,
2 asas
Scodella per zuppa,
2 manici

BACS30D7 10.5 cm - 5.5 cm - 30 cl
4 1/7" - 2 1/5" - 10 1/7 oz



BACS18D7 8.5 cm - 5 cm - 18 cl
3 1/3" - 2" - 6 oz



Saucer

Soucoupe
Untere
Platillo
Piattino

BAST01D7 > BACS30D7
17 cm / 6 2/3"

BASA15D7 > BACS18D7
15 cm / 6"



Salad bowl

Saladier
Salatschale
Ensaladera
Insalatiera

BASP20D7 19.5 cm - 8.5 cm - 105 cl
7 2/3" - 3 1/4" - 37 oz



BASP16D7 16 cm - 7.5 cm - 67 cl
6 2/7" - 3" - 22 2/3 oz



Stackable salad bowl

Saladier empilable
Salatschale stapelbar
Ensaladera apilable
Insalatiera impilabile

BASB21D7 21 cm - 7.5 cm - 118 cl
8 1/5" - 3" - 41 1/2 oz

BASB18D7 18 cm - 6.5 cm - 72 cl
7" - 2 5/8" - 25 1/3 oz



BASB16D7 16 cm - 7 cm - 60 cl
6 2/7" - 2 5/7" - 20 2/7 oz



Bowl

Bol
Schale
Bol
Coppetta

BABW14D7 14 cm - 6.5 cm - 63 cl
5 5/8" - 2 1/2" - 22 1/6 oz

BABW12D7 12 cm - 6.5 cm - 48 cl
4 4/5" - 2 1/2" - 16 8/9 oz



Stackable cup

Tasse empilable
Tasse stapelbar
Taza apilable
Tazza impilabile

BACU23D7 23 cl / 7 7/9 oz

BACU20D7 20 cl / 6 3/4 oz

BACU18D7 18 cl / 6 oz



Saucer

Soucoupe
Untere
Platillo
Piattino

**BASA15D7 > BACU23D7 / BACU20D7
BACU18D7**

15 cm / 6"



Stackable cup

Tasse empilable
Tasse stapelbar
Taza apilable
Tazza impilabile

BACU09D7 9 cl / 3 oz



Saucer

Soucoupe
Untere
Platillo
Piattino

BASA13D7 > BACU09D7

13 cm / 5 1/8"



Coffee pot & lid

Cafetière & couvercle
Kaffeekanne & Deckel
Cafetera & tapa
Caffettiera & coperchio

BACP70D7 70 cl / 23 2/3 oz

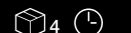

BACP35D7 35 cl / 11 5/6 oz



Lid for coffee pot

Couvercle pour cafetière
Deckel für Kaffeekanne
Tapa para cafetera
Coperchio per caffettiera

BACPLD2D7 > BACP70D7

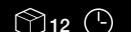

BACPLD1D7 > BACP35D7



Teapot & lid

Théière & couvercle
Teekanne & Deckel
Tetera & tapa
Teiera & coperchio

BATP80D7 80 cl / 27 oz

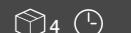

BATP40D7 40 cl / 13 1/2 oz



Lid for teapot

Couvercle pour théière
Deckel für Teekanne
Tapa para tetera
Coperchio per teiera

BATPLD2D7 > BATP80D7



BATPLD1D7 > BATP40D7





Creamer
Crémier
Milchkännchen
Lechera
Bricco da latte
BACR35D7 35 cl / 11 5/6 oz
6
BACR25D7 25 cl / 8 4/9 oz
BACR15D7 15 cl / 5 oz
6



Sugar pack holder
Sucrier pour dosettes
Zuckertütenschale
Azucarero sobres
Portabustine da zucchero
BASH01D7 11 x 7.6 cm - 20 cl
4 4/9 x 3" - 7 oz
6



Toothpick holder
Porte cure-dents
Zahnstocherhalter
Paillero
Portastecchini
BATH01D7 5.5 cm / 2 1/6"
12



Sugar bowl & lid
Sucrier & couvercle
Zuckerdose & Deckel
Azucarero & tapa
Zuccheriera & coperchio
BASU27D7 27 cl / 9 1/8 oz
6



Round sugar pack holder
Sucrier rond à sachets
Zuckertütenschale rund
Azucarero sobres redondo
Contentitore rotondo per pacco di zucchero
BASH02D7 8.5 cm - 23 cl
3 2/5" - 8 oz
12



Ashtray
Cendrier
Ascher
Cenicero
Portacenere
BAAT01D7 10.5 cm / 4"
12

Lid for sugar bowl
Couvercle pour sucrier
Deckel für Zuckerdose
Tapa para azucarero
Coperchio per zuccheriera
BASULDD7
12



Egg cup
Coquetier
Eierbecher
Huevera
Portauovo
BAEG01D7
6



Salt shaker
Salière
Salzstreuer
Salero
Saliera
BASS01D7
6



Flower vase
Vase
Vase
Florero
Vaso
BAFV01D7 15.5 cm / 6"
6



Pepper shaker
Poivrier
Pfefferstreuer
Pimentero
Pepiera
BAPS01D7
6

6 Pieces per box
Pièces par boîte
Stück pro Karton
Piezas por caja
Pezzi per scatola

12 Extra time for deliveries
Délai supplémentaire
Zusätzliche Lieferzeit
Período de abastecimiento adicional
Termine di consegna supplementare



En

The warm fade-resistant colours and elegant design of the SAMBA collection enhance the presentation of buffets and breakfasts. SAMBA creates a harmonious and refreshing décor.

Fr

Les chaudes couleurs inaltérables et le design élégant de la collection SAMBA rehaussent la présentation des buffets et petits-déjeuners. SAMBA construit un décor harmonieux et rafraîchissant.

De

Mit seinem warmen farbechten Farbtönen ist das elegante Design der Kollektion SAMBA ein Gewinn für Buffets und Frühstückstische. SAMBA bildet ein harmonisches und frisches Dekor.

Es

Los inalterables colores cálidos y el elegante diseño de la colección SAMBA realzan la presentación de bufés y desayunos. SAMBA crea una decoración armoniosa y refrescante.

It

I colori caldi e inalterabili e il design elegante della collezione SAMBA mettono in risalto la presentazione dei cibi preparati per buffet e colazioni. SAMBA conferisce un tocco armonioso e rinfrescante.





Noodle Bowl
Bol à nouilles
Nudelschale
Noodle Bol
Coppetta per pasta

15 cm - 6 cm - 63 cl
6" - 2 1/3" - 21 2/7 oz

6

- OPNB15PD1
- OPNB15PD3
- OPNB15PD4
- OPNB15PD5



Chilli bowl
Bol Chili
Schale Chilli
Bol Chilli
Coppetta Chilli

7,5 cm - 6 cm - 18 cl
3" - 2 1/3" - 6 oz

12

- SPCU18PD1
- SPCU18PD3
- SPCU18PD4
- SPCU18PD5



Non-stackable cup
Tasse non empilable
Tasse nicht stapelbar
Taza no apilable
Tazza non impilabile

28 cl - 9 1/2 oz

12

- BANC28PD1
- BANC28PD3
- BANC28PD4
- BANC28PD5
- > BAST01



22 cl - 7 3/7 oz

12

- BANC22PD1
- BANC22PD3
- BANC22PD4
- BANC22PD5
- > BASA15



15 cl - 5 oz

12

- BANC15PD1
- BANC15PD3
- BANC15PD4
- BANC15PD5
- > BASA15



9 cl - 3 oz

12

- BANC09PD1
- BANC09PD3
- BANC09PD4
- BANC09PD5
- > BASA13

 Pieces per box
 Pièces par boîte
 Stück pro Karton
 Piezas por caja
 Pezzi per scatola



Round bowl
Bol rond
Schale rund
Bol redondo
Coppetta rotonda

14 cm - 6,5 cm - 45 cl
5 1/2" - 2 2/3" - 15 1/5 oz

- FDBI14PD1
- FDBI14PD3
- FDBI14PD4
- FDBI14PD5



12 cm - 6 cm - 28 cl
4 5/7" - 2 1/3" - 9 1/2 oz

- FDBI12PD1
- FDBI12PD3
- FDBI12PD4
- FDBI12PD5

11 cm - 5 cm - 22 cl
4 1/3" - 2" - 7 3/7 oz

12

- FDBI11PD1
- FDBI11PD3
- FDBI11PD4
- FDBI11PD5



Flora mug
Chope Flora
Becher Flora
Mug Flora
Mug Flora

36 cl - 12 1/6 oz

12

- BAFMG36PD1
- BAFMG36PD3
- BAFMG36PD4
- BAFMG36PD5
- > BAST01



30 cl - 10 1/7 oz

26 cl - 8 4/5 oz

12

- BAFMG30PD1
- BAFMG30PD3
- BAFMG30PD4
- BAFMG30PD5
- > CLSA01

- BAMG26PD1
- BAMG26PD3
- BAMG26PD4
- BAMG26PD5
- > CLSA01



En

The round and square shapes of the SKA product line offer a perfect platform for a number of culinary uses. Specifically created to be used in mass and commercial catering, the SKA product line has a toughness you can rely on and is very stackable.

Fr

Les formes rondes et carrées de la gamme SKA forment un support parfait pour des utilisations culinaires multiples. Réalisée pour un usage en restauration collective et commerciale, la gamme SKA est dotée d'une solidité à toute épreuve, empilable à loisir.

De

Die runden und eckigen Formen der Kollektion SKA sind die ideale Grundlage für vielfältige gastronomische Einsatzmöglichkeiten. Die Kollektion SKA ist für den Einsatz in der Großgastronomie konzipiert und besonders bruchfest sowie hervorragend stapelbar.

Es

Las formas redondas y cuadradas de la gama SKA forman un soporte perfecto para múltiples usos culinarios. La gama SKA, creada para su uso en restauración colectiva y comercial, está dotada de una solidez a toda prueba, apilable tanto como se quiera.

It

Le forme rotonde e quadrate della gamma SKA offrono un supporto perfetto per molteplici utilizzi culinari. Realizzata per essere impiegata nella ristorazione collettiva e commerciale, la collezione SKA vanta pezzi dalla solidità eccezionale e impilabili a piacimento.





Square flat plate
Assiette plate carrée
Teller flach quadratisch
Plato llano cuadrado
Piatto piano quadrato

SKSFP31 31 cm / 12 1/5"



SKSFP27 27 cm / 10 5/8"

SKSFP24 24 cm / 9 4/9"

SKSFP21 21 cm / 8 1/4"



SKSFP19 19 cm / 7 1/2"

SKSFP17 17 cm / 6 2/3"

SKSFP14 14 cm / 5 1/2"



Round narrow rim deep plate
Assiette creuse ronde coupe
Teller tief rund coupe
Plato hondo redondo coupe
Piatto fondo rotondo senza falda

SKRDP26 26 cm / 10 1/4"

SKRDP22 22 cm / 8 2/3"



Steak platter
Plat à entrecôte
Steak Platte
Fuente steak
Piatto per bistecca

SKRP30 30 x 20 cm / 11 4/5 x 7 7/8"



Square deep plate
Assiette creuse carrée
Teller tief quadratisch
Plato hondo cuadrado
Piatto fondo quadrato

SKSDP27 27 cm / 10 5/8"

SKSDP24 24 cm / 9 4/9"

SKSDP21 21 cm / 8 1/4"



SKSDP15 15 cm / 6"



SKSDP14 14 cm / 5 1/2"



Round bowl
Bol rond
Schale rund
Bol redondo
Coppetta rotonda

SKBWL23 23 cm - 6 cm - 100 cl
9" - 2 1/3" - 33 4/5 oz



SKBWL17 17 cm - 5 cm - 45 cl
6 2/3" - 2" - 15 1/5 oz



Round narrow rim flat plate
Assiette plate ronde coupe
Teller flach rund coupe
Plato llano redondo coupe
Piatto piano rotondo senza falda

SKRFP28 28 cm / 11"

SKRFP24 24 cm / 9 4/9"

SKRFP22 22 cm / 8 2/3"



SKRFP19 19 cm / 7 1/2"

SKRFP16 16 cm / 6 2/7"



Square-round dish
Ravier rond-carré
Schale rund quadratisch
Bol cuadrado redondo
Coppetta rotonda-quadrata

SKSRD16 16 cm - 30 cl
6 2/7" - 10 1/7 oz

SKSRD14 14 cm - 25 cl
5 1/2" - 8 4/9 oz

SKSRD12 12 cm - 18 cl
4 5/7" - 6 oz

SKSRD11 11 cm - 10 cl
4 1/3" - 3 3/8 oz

SKSRD10 10 cm - 7.5 cl
4" - 2 1/2 oz



Rectangular dish
Ravier rectangulaire
Schale rechteckig
Rabanera rectangular
Coppetta rettangolare

SKRTD15 15 x 10 cm - 3.5 cm
6 x 4" - 1 3/8"



Square dish
Ravier carré
Schale quadratisch
Rabanera cuadrada
Coppetta quadrata

SKSTD11 11 cm - 3.4 cm
4 1/3" - 1 1/3"



Stackable bowl
Bol empilable
Schale stapelbar
Bol apilable
Coppetta impilabile

SKBWL60 15 cm - 6 cm - 60 cl
6" - 2 1/3" - 20 2/7 oz

SKBWL40 13 cm - 5.5 cm - 40 cl
5 1/8" - 2 1/5" - 13 1/2 oz



Cream soup bowl, 2 handles
Tasse à bouillon, 2 anses
Suppentasse, 2 Henkel
Bol consommé, 2 asas
Scodella per zuppa, 2 manici

SKCS30 10 cm - 6 cm - 30 cl
4" - 2 1/3" - 10 1/7 oz



Breakfast cup
Tasse à déjeuner
Frühstückstasse
Taza de desayuno
Tazza da colazione

SKCU30 30 cl / 10 1/7 oz



Saucer for breakfast cup & cream soup bowl
Soucoupe pour tasse à déjeuner & tasse à bouillon
Untere für Frühstückstasse & Suppentasse
Platillo para taza de desayuno & bol consommé
Piattino per tazza da colazione e Scodella per zuppa

SKSA16 > SKCU30 / SKCS30

16 cm / 6 2/7"



Coffee/tea cup
Tasse à café/thé
Kaffee/Teetasse
Taza a café/té
Tazza da caffè/tè

SKCU23 23 cl / 7 7/9 oz

SKCU17 17 cl / 5 3/4 oz



Saucer for tea/coffee cup
Soucoupe pour tasse à thé/café
Untere für Tee/Kaffeetasse
Platillo para taza a té/café
Piattino per tazza da caffè/tè

SKSA14 > SKCU23 / SKCU17

14 cm / 5 1/2"





Espresso Cup
Tasse à espresso
Espressotasse
Taza a expreso
Tazza da espresso
SKCU09 9 cl / 3 oz
12



Saucer for espresso cup
Soucoupe pour tasse à espresso
Untere für Espressotasse
Platillo para taza a expreso
Piattino per tazza da espresso
SKSA12 > SKCU09
12 cm / 4 5/7"
12



Mug
Chope
Becher
Mug
Mug
SKSM30 30 cl / 10 1/7 oz
12



Mug
Chope
Becher
Mug
Mug
SKMG22 22 cl / 7 3/7 oz
6



Mug Orchid
Chope Orchid
Becher Orchid
Mug Orchid
Mug Orchid
SKMG33 33 cl / 11 3/5 oz
12



Coffee pot & lid
Cafetière & couvercle
Kaffeekanne & Deckel
Cafetera & tapa
Caffettiera & coperchio
SKCP70 70 cl / 23 2/3 oz
SKCP35 35 cl / 11 5/6 oz
4

Lid for coffee pot
Couvercle pour cafetière
Deckel für Kaffeekanne
Tapa para cafetera
Coperchio per caffettiera
SKCPLD2 > SKCP70
SKCPLD > SKCP35
12



Teapot & lid
Théière & couvercle
Teekanne & Deckel
Tetera & tapa
Teiera & coperchio
SKTP80 80 cl / 27 oz
SKTP40 40 cl / 13 1/2 oz
4

Lid for teapot
Couvercle pour théière
Deckel für Teekanne
Tapa para tetera
Coperchio per teiera
SKTPLD2 > SKTP80
SKTPLD > SKTP40
12



Creamer
Crémier
Milchkännchen
Lechera
Bricco da latte
SKCR15 15 cl / 5 oz
6



Small creamer
Petit crémier
Milchkännchen
Lechera pequeña
Bricco da latte piccolo
103JG02 2 cl / 2/3 oz
6



Sugar holder
Sucrier
Zuckerdose
Azucarero
Zuccheriera
SKSH23 23 cl / 7 7/9 oz
12



Sugar bowl & lid
Sucrier & couvercle
Zuckerdose & Deckel
Azucarero & tapa
Zuccheriera & coperchio
SKSU25 25 cl / 8 4/9 oz
6

Lid for sugar bowl
Couvercle pour sucrier
Deckel für Zuckerdose
Tapa para azucarero
Coperchio per zuccheriera
SKSULD
12



Pepper shaker
Poivrier
Pfefferstreuer
Pimentero
Pepiera
SKPS0 6.5 cm / 2 5/9"
6



Salt shaker
Salière
Salzstreuer
Salero
Saliera
SKSS01 6.5 cm / 2 5/9"
6



Toothpick holder
Porte cure-dents
Zahnstocherhalter
Palillero
Portastecchini
SKTH01 6.5 cm / 2 5/9"
6



12 Pieces per box
Pièces par boîte
Stück pro Karton
Piezas por caja
Pezzi per scatola

12 Extra time for deliveries
Délai supplémentaire
Zusätzliche Lieferzeit
Periodo de abastecimiento adicional
Termine di consegna supplementare

COLLECTION SKOLA

SPECIALTY DINING

205

En

Multicoloured, SKOLA makes lunches fun and provides even the youngest gastronomes with a coloured, practical, and functional collection to awaken their taste buds.

Fr

Multicolore, SKOLA rend les déjeuners ludiques et fournit aux jeunes gastronomes en culottes courtes une collection colorée, pratique et fonctionnelle pour éveiller leurs papilles.

De

Mehrfarbig angelegt, sorgt SKOLA für das spielerische Lernen von Buchstaben und Zahlen, nebenbei beim Mittagessen. Diese außergewöhnliche Dekoration inspiriert die jüngsten unserer Gourmets, eine heitere, praktische Dekoration, die es schafft nicht nur die Geschmacksnerven anzuregen.

Es

La colección multicolor SKOLA hace que los desayunos se conviertan en diversión y ofrece a los gastrónomos más pequeños una colección llena de color, práctica y funcional para despertar sus papilas.

It

La linea multicolore SKOLA rende divertente la colazione e offre ai buongustai più giovani una collezione variopinta, pratica e funzionale per risvegliare le papille gustative.

DESIGN BY FRANÇOISE BŒUR





Flat plate

Assiette plate
Teller flach
Plato llano
Piatto piano

NN24012001 24 cm / 9 4/9"

12



NN18012001 18 cm / 7"

24



Salad bowl

Saladier
Salatschale
Ensaladera
Insalatiera

BA18042001 18 cm - 6.5 cm - 72 cl
7" - 2 5/9" - 24 1/3 oz

12



Bowl

Bol
Schale
Bol
Coppetta

SK40212001 13 cm - 5.5 cm - 40 cl
5 1/8" - 2 5/9" - 13 1/2 oz

12



Square flat plate

Assiette plate carrée
Teller flach quadratisch
Plato llano cuadrado
Piatto fondo quadrato

SK21012001 21 cm / 8 1/4"

12



Square flat plate

Assiette plate carrée
Teller flach quadratisch
Plato llano cuadrado
Piatto fondo quadrato

SK15022001 15 cm / 6"

24



Mug

Chope
Becher
Mug
Mug

BA26082001 7.6 cm - 26 cl
3" - 8 4/5 oz

6



Square-round dish

Ravier rond-carré
Schale rund quadratisch
Bol cuadrado redondo
Coppetta rotonda-
quadrata

SK12162001 12 cm / 4 5/7"

24



COLLECTION
TRIO

CASUAL DINING

209

En

The TRIO collection elegantly juxtaposes triangular shapes with soft lines. The coffee service pieces are remarkable for their silhouette married with their toughness.

Fr

La collection TRIO juxtapose avec élégance des formes triangulaires et des lignes adoucies. Les pièces de cafétéria sont remarquables par leur silhouette et leur robustesse.

De

Die Kollektion TRIO bildet eine Kombination von Dreiecksformen mit geschwungenen Linien. Die Hohlteile fallen wegen ihrer außergewöhnlichen Silhouette und Robustheit besonders auf.

Es

La colección TRIO yuxtapone con elegancia formas triangulares y líneas suavizadas. Las piezas de cafetería destacan por su silueta y su robustez.

It

La collezione TRIO accosta con eleganza forme triangolari e linee morbide. I pezzi da caffetteria sono eccellenti per la loro silhouette e robustezza.





Rectangular flat plate
Assiette plate rectangulaire
Teller flach rechteckig
Plato llano rectangular
Piatto piano rettangolare

TGRP41 41.5 x 21 cm
16 1/3 x 8 1/3"

TGRP31 31 x 23 cm
12 1/6 x 9"

📦 12 🕒



Flat plate
Assiette plate
Teller flach
Plato llano
Piatto piano

TGFP29 29 cm / 11 1/4"

TGFP27 27 cm / 10 1/2"

TGFP24 24 cm / 9 3/8"

📦 12 🕒

TGFP19 19 cm / 7 1/2"

📦 24 🕒



Deep plate
Assiette creuse
Teller tief
Plato hondo
Piatto fondo

TGDP30 30 cm - 100 cl
11 2/3" - 35 1/5 oz

📦 6 🕒

TGDP26 26 cm - 55 cl
10 2/5" - 19 1/3 oz

TGDP23 23 cm - 44 cl
9" - 15 1/2 oz

📦 12 🕒



Bowl
Bol
Schale
Bol
Coppetta

TGBW18 18 cm - 7.5 cm - 78 cl
7 1/6" - 3" - 27 4/9 oz

TGBW12 12 cm - 5 cm - 23 cl
4 5/6" - 1 8/9" - 8 oz

📦 12 🕒



Cream soup bowl, 2 handles
Tasse à bouillon, 2 anses
Suppentasse, 2 Henkel
Bol consommé, 2 asas
Scodella per zuppa, 2 manici

TGCS30 10.5 cm - 5.5 cm - 30 cl
4 1/6" - 2 1/4" - 10 5/9 oz

📦 6 🕒



Saucer
Soucoupe
Untere
Platillo
Piattino

TGSA17 > TGCS30

17 cm - 6 7/9"

📦 24 🕒



Coffee/tea cup
Tasse à café/thé
Kaffee-/Teetasse
Taza a café/té
Tazza da caffè/tè

TGCU23 8.5 cm - 23 cl
3 2/5" - 8 oz

📦 12 🕒



Coffee cup
Tasse à café
Kaffeetasse
Taza a café
Tazza da caffè

TGCU20 7.5 cm - 20 cl
2 7/8" - 7 oz

📦 12 🕒



Saucer
Soucoupe
Untere
Platillo
Piattino

TGSA15 > TGCU23 / TGCU20

15 cm / 6"

📦 12 🕒



Espresso cup
Tasse à espresso
Espressotasse
Taza a expreso
Espresso cup
Tazza da espresso

TGCU09 6 cm - 9 cl
2 1/3" - 3 1/6 oz

📦 12 🕒



Saucer
Soucoupe
Untere
Platillo
Piattino

TGSA13 > TGCU09

13 cm / 5 1/6"

📦 12 🕒



Teapot & lid
Théière & couvercle
Teekanne & Deckel
Tetera & tapa
Teiera & coperchio

TGTP80 80 cl / 28 1/6 oz

TGTP40 40 cl / 14 oz

📦 4 🕒



Creamer
Crémier
Milchkännchen
Lechera
Bricco da latte

TGCR15 15 cl / 5 2/7 oz

📦 6 🕒



Sugar bowl & lid
Sucrier & couvercle
Zuckerdose & Deckel
Azucarero & tapa
Zuccheriera & coperchio

TGSU22 22 cl / 7 3/4 oz

📦 6 🕒



Salt shaker
Salière
Salzstreuer
Salero
Saliera

TGSS01

📦 6 🕒



Pepper shaker
Poivrier
Pfefferstreuer
Pimentero
Pepiera

TGPS01

📦 6 🕒

🕒 These items or collections are custom made, so please allow additional time for delivery.

Ces articles ou collections sont produits à la demande, prévoir un délai d'approvisionnement supplémentaire.

Diese Artikel oder Kollektionen werden entsprechend der Nachfrage hergestellt, eine zusätzliche Lieferzeit einplanen.

Estos artículos o colecciones se fabrican en función de la demanda. Debe fijarse un periodo de abastecimiento adicional.

Questi articoli o collezioni sono prodotti su richiesta, si prega di quindi di prevedere un termine di consegna supplementare.

📦 Pieces per box
Pièces par boîte
Stück pro Karton
Piezas por caja
Pezzi per scatola



COLLECTION
WHITE GOLD

INSPIRATIONAL DINING

213

En

The grace of its baroque curves gives WHITE GOLD a princely appeal. Carved like lacework, this collection delicately presents your culinary showpieces, from the simplest ones to the most sophisticated.

Fr

Avec la grâce de ses courbes baroques, WHITE GOLD arbore une allure princière. Ciselée comme de la dentelle, cette collection présente avec délicatesse les œuvres culinaires des plus simples aux plus recherchées.

De

Mit der barocken Linienführung strahlt die Kollektion WHITE GOLD eine fürstliche Anmut aus. Ziseliert wie feinste Spitze präsentiert diese Kollektion mit Zartheit kulinarische Werke von ganz schlichter bis höchst komplexer Art.

Es

WHITE GOLD, con la gracia de sus curvas barrocas, hace gala de un aspecto principesco. Esta colección, tallada como si fuera de encaje, presenta con delicadez las más sencillas y solicitadas obras culinarias.

It

Con la grazia delle sue curve barocche, la linea WHITE GOLD sfoggia un fascino principesco. Cesellata in maniera tale da richiamare alle mente pizzi e merletti, questa collezione presenta con delicatezza le opere culinarie più semplici e quelle più ricercate.





KING

Serving tray rectangular

Plat rectangulaire
Platte rechteckig
Bandeja servicio rectangular
Vassoio da portata rettangolare

GDRT42 42 x 32,5 cm
16 1/2 x 12 4/5"

6



Square plate

Assiette carrée
Teller quadratisch
Plato cuadrado
Piatto quadrato

GDSP34 34 cm / 13 2/5"

6

GDSP26 26 cm / 10 1/4"

12



QUEEN

Round plate

Assiette ronde
Teller rund
Plato redondo
Piatto rotondo

GDRP31 31 cm / 12 1/5"

6

GDRP28G 28 cm / 11"

6



Round plate

Assiette ronde
Teller rund
Plato redondo
Piatto rotondo

GDRP28 28 cm / 11"

6

GDRP22 22 cm / 8 2/3"

12

GDRP16 16 cm / 6 2/7"

24



PRINCE

Deep plate

Assiette creuse
Teller tief
Plato hondo
Piatto fondo

GDDP29 29 cm / 11 3/7"

GDDP23 23 cm / 9"

6



PRINCESS

Scallop plate

Assiette festonnée
Teller festoniert
Plato scallop
Piatto smerlato

GDSP33 33 cm / 13"

6



Soup tureen & lid

Soupière & couvercle
Suppenterrine & Deckel
Sopera & tapa
Zuppiera & coperchio

GDSB340 340 cl / 115 oz

1

Lid for soup bowl tureen

Couvercle pour soupière
Deckel für Suppenterrine
Tapa para sopra
Coperchio per zuppiera

GDSBLD

6



Tea cup

Tasse à thé
Teetasse
Taza a té
Tazza da tè

GDCU21 21 cl / 7 oz

12



Bowl

Bol
Schale
Bol
Copetta

GDCU21M 21 cl / 7 oz

12



Saucer

Soucoupe
Untere
Platillo
Piattino

GDSA15 > GDCU21M / GDCU21

15 cm / 6"

12



Espresso cup

Tasse à espresso
Espressotasse
Taza a expreso
Tazza da espresso

GDCU09 9 cl / 3 oz

12



Bowl

Bol
Schale
Bol
Copetta

GDCU09M 9 cl / 3 oz

12



Saucer

Soucoupe
Untere
Platillo
Piattino

GDSA12 > GDCU09M / GDCU09

12 cm / 4 5/7"

12





Coffee pot & lid
Cafetière & couvercle
Kaffeekanne & Deckel
Cafetera & tapa
Caffettiera & coperchio
GDCP160 160 cl / 54 oz
📦4 ⌚

Lid for coffee pot
Couvercle pour cafetière
Deckel für Kaffeekanne
Tapa para cafetera
Coperchio per caffettiera
GDCPLD
📦12 ⌚



Teapot & lid
Théière & couvercle
Teekanne & Deckel
Tetera & tapa
Teiera & coperchio
GDTP150 150 cl / 50.5/7 oz
📦4 ⌚

Lid for teapot
Couvercle pour théière
Deckel für Teekanne
Tapa para tetera
Coperchio per teiera
GDTPLD
📦12 ⌚



Creamer
Crémier
Milchkännchen
Lechera
Bricco da latte
GDCR25 25 cl / 8.4/9 oz
📦6



Sugar bowl & lid
Sucrier & couvercle
Zuckerdose & Deckel
Azucarero & tapa
Zuccheriera & coperchio
GDSU25 25 cl / 8.4/9 oz
📦6

Lid for sugar bowl
Couvercle pour sucrier
Deckel für Zuckerdose
Tapa para azucarero
Coperchio per zuccheriera
GDSULD
📦12

📦 Pieces per box
Pièces par boîte
Stück pro Karton
Piezas por caja
Pezzi per scatola

⌚ Extra time for deliveries
Délai supplémentaire
Zusätzliche Lieferzeit
Período de abastecimiento adicional
Termine di consegna supplementare



En

On the following pages you will find a selection of items designed specifically for mini portions. Even the most minimalist of presentations are stunningly displayed on these miniature pieces.

Fr

Retrouvez sur ces pages une sélection d'articles particulièrement adaptés aux mini-portions. Ces pièces miniatures mettent brillamment en scène les présentations même les plus minimalistes.

De

Auf den nächsten Seiten finden Sie eine Auswahl an Artikeln, die sich ganz besonders für sehr kleine Portionen eignen. Diese Miniaturteile setzen selbst die minimalistischsten Speisen wirkungsvoll in Szene.

Es

En estas páginas encontrará una selección de artículos especialmente adaptados a las minirraciones. Estas piezas miniaturas ponen perfectamente en escena las presentaciones más minimalistas.

It

Ritrovate su queste pagine una selezione di articoli particolarmente adatti alle mini porzioni. Questi pezzi in miniatura mettono in scena in modo particolarmente brillante le scenografie più minimaliste.

ALLSPICE



Round bowl

Bol rond
Schale rund
Bol redondo
Coppetta rotonda

SPCB32 14 cm - 3.5 cm - 32 cl
5 1/2" - 1 3/8" - 10 4/5 oz

SPCB20 11 cm - 3.5 cm - 20 cl
4 1/3" - 1 3/8" - 6 3/4 oz

SPCB11 8 cm - 3.5 cm - 11 cl
3 1/7" - 1 3/8" - 3 5/7 oz



Cup without handle

Tasse sans anse
Tasse ohne Henkel
Taza sin asa
Tazza senza manici

SPCU09 9 cl / 3 oz

SPCU07 7 cl / 2 3/8 oz



Bowl

Bol
Schale
Bol
Coppetta

SPCU18 7.5 cm - 6 cm - 18 cl
3" - 2 1/3" - 6 oz



Oval flat plate

Assiette plate ovale
Teller flach oval
Plato llano oval
Piatto piano ovale

SPEG19 19 x 16 cm / 7 1/2 x 6 2/7"



Square plate, 1 rectangular indent

Assiette carrée, 1 encoche rectangulaire
Teller quadratisch, 1 rechteckige Fläche
Plato cuadrado, 1 estanque rectangular
Piatto quadrato, 1 inserto rettangolare

SPDP19 19 cm / 7 1/2"



Oval flat plate

Assiette plate ovale
Teller flach oval
Plato llano oval
Piatto piano ovale

SPEY19 19 x 14 cm / 7 1/2 x 5 1/2"



Oval plate, 1 rectangular indent

Plat ovale, 1 encoche rectangulaire
Platte oval, 1 rechteckige Fläche
Fuente oval, 1 estanque rectangular
Piatto ovale, 1 inserto rettangolare

SPTM30 30 x 12 cm
11 4/5 x 4 5/7"



BANQUET



Cream soup bowl, 2 handles
Tasse à bouillon, 2 anses
Suppentasse, 2 Henkel
Bol consommé, 2 asas
Scodella per zuppa, 2 manici
BACS18 8.5 cm - 5 cm - 18 cl
3 1/3" - 2" - 6 oz
6



Ristretto cup
Tasse ristretto
RistrettoTasse
Taza ristretto
Tazza ristretto
BANC07 7 cl / 2 3/8 oz
12



Butter ramekin
Ramequin à beurre
Butterschälchen
Platillo para mantequilla
Coppetta da burro
BABR01 6.7 cm - 6 cl / 2 2/3" - 2 oz
12



Continental sauce dish
Plat à sauce continental
Saucenschale continental
Salsiera continental
Salsiera continentale
BACD09 9 x 7 cm / 3 1/2 x 2 3/4"
12



Salad bowl
Saladier
Salatschale
Ensaladera
Insalatiera
BASP12 12 cm - 6 cm - 31 cl
4 5/7" - 2 1/3" - 10 1/2 oz
12



Stackable butter ramekin
Ramequin à beurre empilable
Butterschälchen stapelbar
Platillo para mantequilla apilable
Coppetta da burro impilabile
BABR03 7 cm - 3 cm - 6 cl
2 3/4" - 1 1/16" - 2 oz
12



Butter dish
Assiette à beurre
Butterteller
Plato mantequilla
Piatto da burro
BABD11 11 x 8 cm / 4 1/3 x 3 1/7"
12



Flower dish
Coupelle fleur
Schale in Blumenform
Concha flor
Coppetta fiore
BAFD01 9 cm - 15 cl
3 1/2" - 5 2/7 oz
12



Large mezza bowl
Grand bol mezza
Mezza Schale groß
Bol mezza grande
Coppetta mezza grande
BAMB17 17 cm - 4 cm - 36 cl
6 2/3" - 1 4/7" - 12 1/6 oz
12



Stackable butter ramekin
Ramequin à beurre empilable
Butterschälchen stapelbar
Platillo para mantequilla apilable
Coppetta da burro impilabile
BABR02 8 cm - 3.5 cm - 10 cl
3 1/7" - 1 3/8" - 3 3/8 oz
12



Egg cup
Coquetier
Eierbecher
Huevera
Portauovo
BAEG01
6



Small mezza bowl
Petit bol mezza
Mezza Schale klein
Bol mezza pequeño
Coppetta mezza piccola
BAMB13 13 cm - 4 cm - 17 cl
5 1/8" - 1 4/7" - 5 3/4 oz
6



Toothpick holder
Porte cure-dents
Zahnstocherhalter
Palillero
Portastecchini
BATH01 7 cl / 2 3/8 oz
12

FINE DINE



Oval salad bowl
Saladier ovale
Salatschale oval
Ensaladera oval
Insalatiera ovale

FDBO16 16 x 11 cm - 5 cm
6 2/7" x 4 1/3" - 2"

6



Round bowl
Bol rond
Schale rund
Bol redondo
Coppetta rotonda

FDBI08 8 cm - 4 cm - 11 cl
3 1/7" - 1 4/7" - 3 5/7 oz

12

MASSILIA



Coffee/tea cup
Tasse à café/thé
Kaffee-/Teetasse
Taza a café/té
Tazza da caffè/tè

MSCU17 8 cm - 17 cl
3 1/7" - 5 5/7 oz

12



Espresso cup without handle
Tasse à espresso sans anse
Espressotasse ohne Henkel
Taza a expreso sin asa
Tazza da espresso senza manici

MSCU10M 6 cm - 11 cl
2 1/3" - 3 2/3 oz

12

MAZZA



Cocktail plate
Assiette cocktail
Cocktailteller
Plato cóctel
Piatto cocktail

MZCP32 32 x 9,5 cm
12 3/5" x 3 5/7"

MZCP26 26 x 7,5 cm
10 1/4" x 3"

MZCP20 20 x 6,5 cm
7 7/8" x 2 1/2"

6



Mini rectangular dish
Coupelle rectangulaire
Schale rechteckig
Rabanera mini rectangular
Mini coppetta rettangolare

MZMR11 11 x 5,5 cm
4 1/4" x 2 1/8"

6



Mini square dish
Coupelle carrée
Schale quadratisch
Rabanera mini cuadrada
Mini coppetta quadrata

MZMS08 8 x 7,5 cm
3 1/7" x 3"

6

MINIMAX



Sandwich tray
Plat à sandwich
Sandwichplatte
Bandeja sándwich
Vassoio sandwich
OPSP14 14 x 8 cm
5 1/2 x 3 1/7"
12



Soup spoon
Cuillère à soupe
Suppenlöffel
Cuchara de sopa
Cucchiaio da tavola
ACSP01 12 cm / 4 5/7"
24



Mini pan with grip
Mini poêlon avec poignée
Mini Pfanne mit Griff
Mini sartén con asa
Mini tegame
MNMP01 6.2 cm / 2 4/9"
12



Asymmetric dish
Coupelle asymétrique
Schale asymmetrisch
Bol asimétrico
Coppetta asimmetrica
OPAB06 6 cm - 2 cm
2 1/3" - 4/5"
12



Square bowl
Bol carré
Schale quadratisch
Bol cuadrado
Coppetta quadrata
OPSB09 9 cm - 5 cm - 17 cl
3 1/2" - 2" - 5 3/4 oz
6



High cube
Cube haut
Kubus hoch
Cubo alto
Coppetta a cubo alta
OPSD01 5 cm - 5.5 cm - 9 cl
2" - 2 1/6" - 3 oz
12



Square sauce dish
Bol à sauce carré
Saucenschale quadratisch
Bol salsa cuadrado
Salsiera quadrata
ACSD01 7.5 cm - 3 cm
3" - 1 1/6"
6



Miniature round bowl
Miniature bol rond
Miniatureschale rund
Miniatura bol redondo
Miniatura coppetta rotonda
OPCU05 5 cl / 1 2/3 oz
12

OPSB08 8 cm - 4 cm - 10.5 cl
3 1/7" - 1 4/7" - 3 5/9 oz
12
OPSB07 7 cm - 3.5 cm - 7 cl
2 3/4" - 1 3/8" - 2 3/8 oz
6
OPSB04 4 cm / 1 4/7"
24



Small cube
Cube bas
Kubus klein
Cubo bajo
Coppetta a cubo piccola
OPSD02 5 cm - 4.5 cm - 6 cl
2" - 1 7/9" - 2 oz
12



Rectangular twin sauce bowl
Coupelle à sauce double
Doppelte Saucenschale rechteckig
Bol salsa doble rectangular
Coppetta per salsa doppia rettangolare
ACTS01 14.5 x 7 cm - 3 cm
5 5/7 x 2 3/4" - 1 1/6"
6



Egg cup
Coquetier
Eierbecher
Huevera
Portauovo
OPEG01
12



Yin Yang saucer
Yin Yang saucière
Yin Yang Sauciere
Salsera Yin Yang
Salsiera Yin Yang
ACY01 10 cm / 4"
24



Square creamer/gravy boat
Crémier/saucière carré
Saucière/Milchkännchen quadratisch
Salsera/lechera cuadrada
Salsiera/bricco da latte quadrato
OPSD03 5 cm - 6 cm - 8 cl
2" - 2 2/7" - 2 4/5 oz
12

MINIMAX



Mini boat bowl

Mini bol bateau
Mini Bootschale
Mini bol barco
Mini coppetta barca

MINOD05 7.3 x 4.5 cm - 3 cm - 3 cl
2 7/8 x 1 7/8" - 1 1/8" - 1 oz

6



Bowl

Bol
Schale
Bol
Coppetta

NAMB16 16 cm - 3.5 cm - 12 cl
6 2/7" - 1 3/8" - 4 oz

24

NABUR



Party plate

Assiette cocktail
Cocktailteller
Plato cóctel
Piatto co

NBPP22 22 x 15.5 cm
8 2/3 x 6 1/9"

12

NANO



Butter dish

Assiette à beurre
Butterschale
Plato mantequilla
Piatto da burro

NNBD09 9 cm / 3 1/2"
NNBD07 7 cm / 2 3/4"

12



Round bowl Katori

Bol rond Katori
Schale rund Katori
Bol redondo Katori
Coppetta rotonda Katori

MNRD10 10 cm - 4.5 cm - 18 cl
4" - 1 3/4" - 6 oz

12



Triangular bowl

Bol triangulaire
Schale dreieckig
Bol triangular
Coppetta triangolare

OPTB12 12 cm - 25.5 cl / 4 5/7" - 8 5/8 oz
OPTB10 10 cm - 15.5 cl / 3 3/4" - 5 1/4 oz

12



Dip bowl

Coupelle
Schälchen
Bol hondo
Coppetta

NBDB08 8 x 6.5 cm - 2 cm - 4 cl
3 1/7 x 2 5/9" - 4/5" - 1 1/3 oz

12



Non stackable bowl

Bol non empilable
Schale nicht stapelbar
Bol no apilable
Coppetta non impilabile

NNBW10 10 cm - 5 cm - 16 cl
4" - 2" - 5 2/5 oz

NNBW09 9 cm - 4 cm - 11 cl
3 1/2" - 1 4/7" - 3 5/7 oz

12



Spoon

Cuillère
Löffel
Cuchara
Cucchiaio

NNSP14 14 cm / 5 1/2"

12

NORDIC



Mise en bouche/cup
 Mise en bouche/tasse
 Mise en bouche/Tasse
 Mise en bouche/taza
 Mise en bouche/tazza

NOMB1 9 cl / 3 oz
 12



Saucer for Breakfast/tea cup
 Soucoupe pour tasse à déjeuner/thé
 Untere für Frühstücks/Teetasse
 Platillo para taza a desayuno/té
 Piattino per tazza da colazione/té

NOSA3 > NOCU30
 15.5 cm / 6 1/9"
 6



Saucer for coffee cup
 Soucoupe pour tasse à café
 Untere für Kaffeetasse
 Platillo para taza a café
 Piattino per tazza da caffè

NOSA2 > NOCU20
 14 cm / 2"
 6



Saucer for espresso cup
 Soucoupe pour tasse à espresso
 Untere für Espressotasse
 Platillo para taza a expreso
 Piattino per tazza da espresso

NOSA1 > NOCU09
 10 cm / 4"
 12

SKA



Square-round dish
 Ravier rond-carré
 Schale rund quadratisch
 Bol cuadrado redondo
 Coppetta rotonda-quadrata

SKSRD12 12 cm - 18 cl
 4 5/7" - 6 oz
SKSRD11 11 cm - 10 cl
 4 1/3" - 3 3/8 oz
SKSRD10 10 cm - 7.5 cl
 4" - 2 1/2 oz

 24



Small creamer
 Petit crémier
 Milchkännchen
 Lechera pequeña
 Bricco da latte piccolo

103JG02 2 cl / 2/3 oz
 6

En

Specially designed to meet the needs and constraints required by their users, these items fit perfectly within the standard meal transport and reheating systems that are already on the market.

Fr

Mis au point spécialement pour répondre aux exigences et contraintes requises par les utilisateurs, les pièces s'intègrent parfaitement dans les systèmes standards de transport de repas ou de remise en température présents sur le marché.

De

Speziell entwickelt für die Bedürfnisse und Anforderungen ihrer Benutzer, passen diese Artikel perfekt zu den standardisierten Speisentransport- und Wiedererwärmungssystemen, die bereits auf dem Markt vertreten sind.

Es

Concepito appositamente per rispondere alle esigenze e alle limitazioni dei pazienti. Questi pezzi si integrano perfettamente nei sistemi standard per trasportare o riportare a temperatura gli alimenti presenti sul mercato.

It

Especialmente diseñados en atención a las necesidades y las restricciones de los usuarios, estos artículos responden de manera ideal a los sistemas comúnmente empleados para el transporte de alimentos y para su recalentamiento actualmente existentes en el mercado.



Unglazed flat bottom
Fond plat non-émailié
Boden unglasiert ohne Fuß
Fondo plano sin esmaltar
Fondo piatto smaltato



**Healthcare flat plate
2 compartments**

Assiette plate patient
Flacher Systemteller
2 compartiments
Flacher Systemteller
2 Einteilungen
Plato llano paciente
2 compartimentos
Piatto piano paziente
2 compartimenti

SKHDP23 23 cm / 9"

12



Healthcare flat plate

Assiette plate patient
Flacher Systemteller
Plato llano paciente
Piatto piano paziente

SKHFP23 23 cm - 2.6 cm
9" - 1"

12



Healthcare flat plate with wide rim

Assiette plate patient aile large
Flacher Systemteller mit breitem Rand
Plato llano paciente con borde ancho
Piatto piano paziente con bordo largo

SKHFP23WR 23 cm - 2.2 cm
9" - 6/7"

12

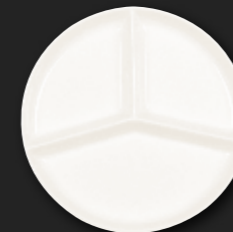

**Healthcare flat plate
3 compartments**

Assiette plate patient
3 compartiments
Flacher Systemteller
3 Einteilungen
Plato llano paciente
3 compartimentos
Piatto piano paziente
3 compartimenti

ZADP24 24 cm - 2.6 cm
9 4/9" - 1"

6

ZADP21 21 cm - 2.6 cm
8 1/4" - 1"

12



Healthcare flat plate

Assiette plate patient
Flacher Systemteller
Plato llano paciente
Piatto piano paziente

ZARFP20 20 cm - 2.2 cm
7 7/8" - 6 7/8"

12



Straight round bowl

Bol rond droit
Schale rund gerade
Bol redondo recto
Coppetta rotonda dritta

ZABW50 13 cm - 5.5 cm - 50 cl
5 1/8" - 2 1/6" - 17 oz

12



Non stackable bowl

Bol non empilable
Schale nicht stapelbar
Bol no apilable
Coppetta non impilabile

ZABW44 15 cm - 5.5 cm - 44 cl
6" - 2 1/6" - 14 7/8 oz

12



Soup bowl with handle

Tasse bouillon, 2 anses
Suppentasse, 2 Henkel
Bol consommé, 2 asas
Scodella per zuppa,
2 manici

ZASB28 10 cm - 6 cm - 28 cl
4" - 2 2/7" - 9 1/2 oz

12



Salad bowl

Saladier
Salatschale
Ensaladera
Insalatiera

ZASB21 10 cm - 5 cm - 21 cl
4" - 1 8/9" - 7 oz

12



Rectangular bowl
 Ravier rectangulaire
 Schale rechteckig
 Rabanera rectangular
 Coppetta rettangolare
ZARB16 16 x 10 cm - 33 cl
 6 2/7 x 4" - 11 1/6 oz
 12



Rectangular dish
 Ravier rectangulaire
 Schale rechteckig
 Rabanera rectangular
 Coppetta rettangolare
SKRTD15 15 x 10 cm - 22 cl
 6 x 4" - 7 3/7 oz
 12



Saucer
 Soucoupe
 Untertasse
 Platillo
 Piattino
BAST01 > BACS30 / BASB12 / BACS01
 17 cm / 6 2/3"
 12



Teapot & lid
 Théière & couvercle
 Teekanne & Deckel
 Tetera & tapa
 Teiera & coperchio
BATP40 40 cl / 13 1/2 oz
 4



Rectangular bowl
 Ravier rectangulaire
 Schale rechteckig
 Rabanera rectangular
 Coppetta rettangolare
ZARB21 21 x 6 cm - 12 cl
 8 1/4 x 2 1/3" - 4 oz
 12



Bowl stackable
 Bol empilable
 Schale stapelbar
 Bol apilable
 Coppetta impilabile
SKBWL40 13 cm - 5.5 cm - 40 cl
 5 1/8" - 2 1/5" - 13 1/2 oz
 12



Stackable salad bowl
 Saladier empilable
 Salatschale stapelbar
 Ensaladera apilable
 Insalatiera impilabile
BASB16 16 cm - 7 cm - 60 cl
 6 2/7" - 2 5/7" - 20 2/7 oz
BASB12 12 cm - 5.5 cm - 25 cl
 4 5/7" - 2 1/8" - 8 4/9 oz
 12



Stackable cup
 Tasse empilable
 Tasse stapelbar
 Taza apilable
 Tazza impilabile
BACU23 23 cl / 7 7/9 oz
 12



Sunshine mug
 Chope Sunshine
 Becher Sunshine
 Mug Sunshine
 Mug Sunshine
OPSMG24 24 cl / 8 1/9 oz
 12



Cream bowl, 2 handles
 Tasse à bouillon, 2 anses
 Suppentasse, 2 Henkel
 Bol consommé, 2 asas
 Scodella per zuppa, 2 manici
PXCS35 11.5 cm - 6.5 cm - 35 cl
 4 1/2" - 2 3/5" - 11 5/6 oz
 12



Stackable mug
 Chope empilable
 Becher stapelbar
 Mug apilable
 Mug impilabile
BASM30 30 cl - 10 1/7 oz
 12



Saucer
 Soucoupe
 Untertasse
 Platillo
 Piattino
BASA15 > BACU23
 15 cm / 6"
 12



Rectangular dish
 Ravier rectangulaire
 Schale rechteckig
 Platillo rectangular
 Coppetta rettangolare
ACRD10 10 x 5.8 cm - 8 cl
 4 x 2 2/7" - 2 5/7 oz
 6



Bowl
 Bol
 Schale
 Bol
 Coppetta
BABW14 14 cm - 6 cm - 63 cl
 5 1/2" - 2 1/3" - 21 2/7 oz
BABW12 12 cm - 6 cm - 48 cl
 4 5/7" - 2 1/3" - 16 2/9 oz
 12



Square dish
 Ravier carré
 Schale quadratisch
 Rabanera cuadrada
 Coppetta quadrata
SKSTD11 11 cm - 21 cl
 4 1/3" - 7 oz
 12



Cream soup bowl, 2 handles
 Tasse à bouillon, 2 anses
 Suppentasse, 2 Henkel
 Bol consommé, 2 asas
 Scodella per zuppa, 2 manici
BACS30 10.5 cm - 5.5 cm - 30 cl
 4 1/7" - 2 1/5" - 10 1/7 oz
 6



Egg cup
 Coquetier
 Eierbecher
 Huevera
 Portauovo
BAEG01
 6

En

Discover the wide variety of services of cups and saucers created by RAK Porcelain for hot drinks, whose attractive appearance and functionality will meet all of your expectations.

Fr

Découvrez la variété de services de tasses et sous-tasses dédiées aux boissons chaudes créées par RAK Porcelaine pour répondre à toutes vos attentes esthétiques et fonctionnelles.

De

Entdecken Sie die Vielfalt an Geschirr mit Tassen und Untertassen für heiße Getränke, die von RAK Porzellan entworfen wurden, um all Ihre Ansprüche an Ästhetik und Funktionalität zu erfüllen.

Es

Descubra la gran variedad de servicios de tazas y platos para bebidas calientes creados por RAK Porcelain para responder a todas sus expectativas estéticas y funcionales.

It

Scoprite la varietà di servizi di tazze e sotto-tazze per bevande calde create da RAK Porcelain per rispondere a tutte le vostre esigenze estetiche e funzionali.

CLSA01
Universal Saucer
15 cm / 6"

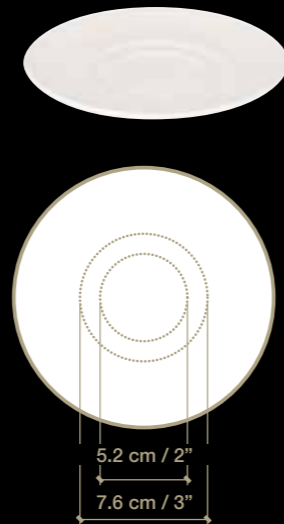

CLSA02
Universal Saucer
17 cm / 6 2/3"



SPRP18IN
Allspice
18 x 14 cm
7 x 5 1/2"

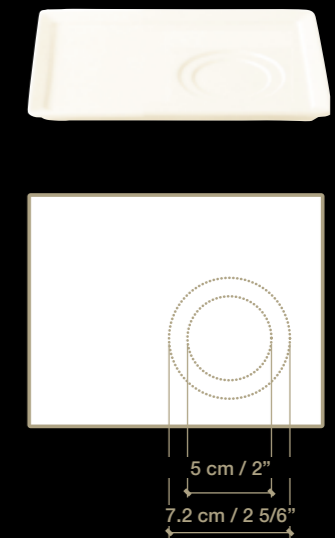

SPRP24IN
Allspice
24 x 14 cm
9 4/9 x 5 1/2"

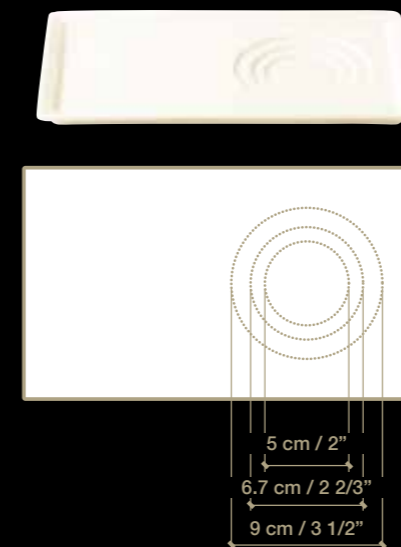

SPRP28IN
Allspice
28 x 14 cm
11 x 5 1/2"

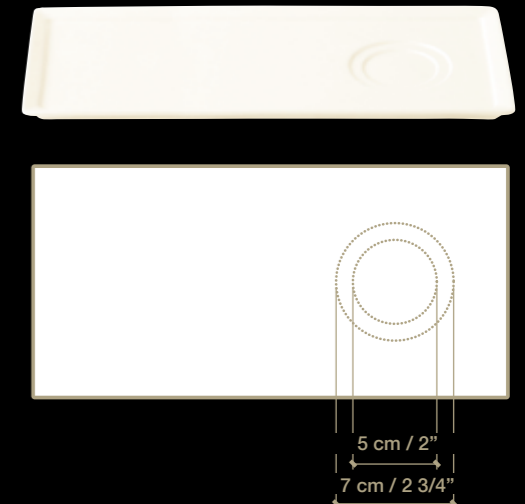

NABUR

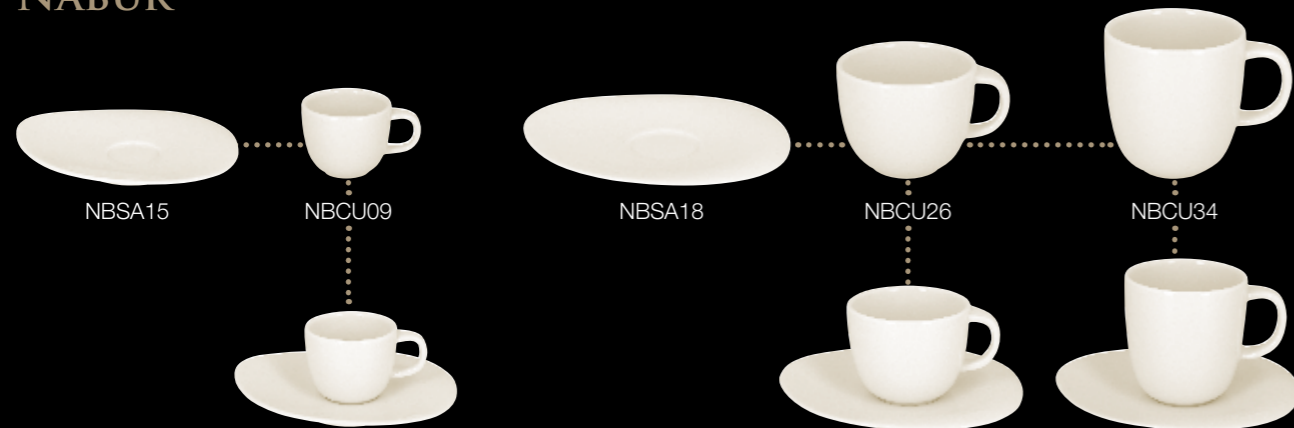

GIRO NEW

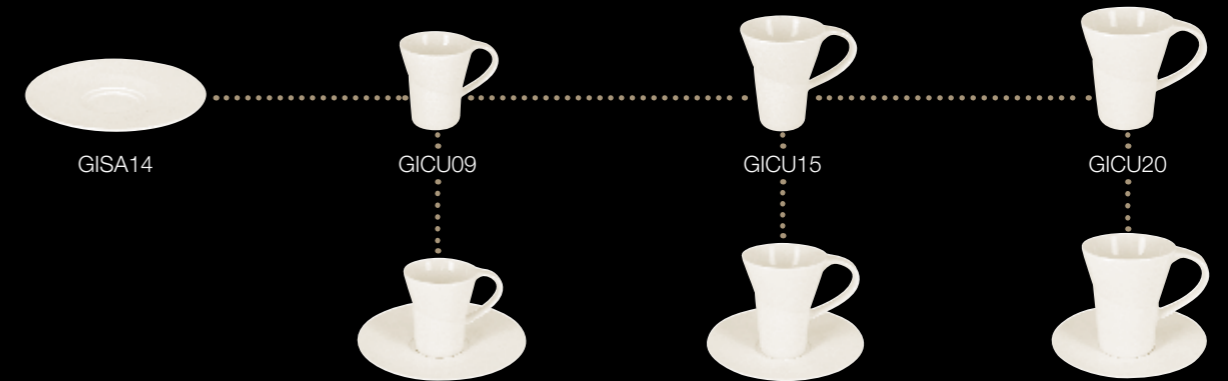

BANQUET

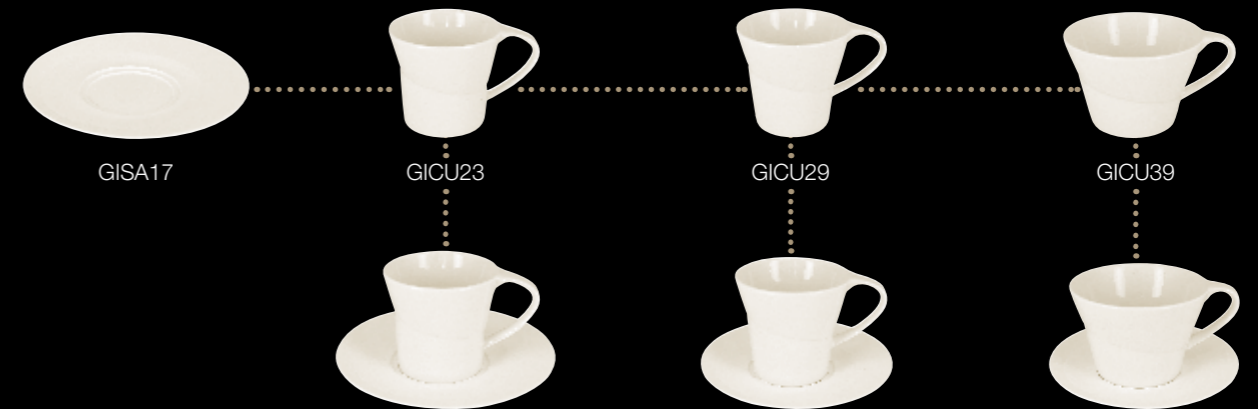

FINE DINE

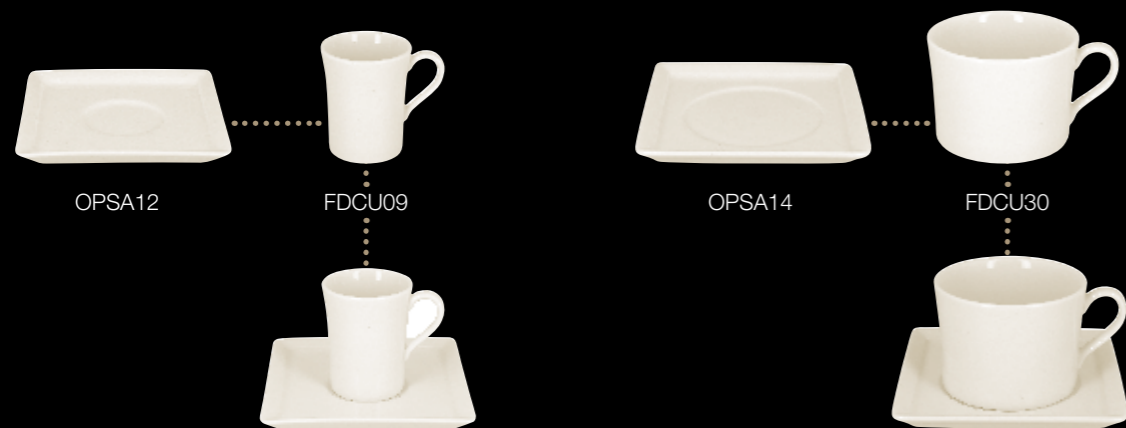

BANQUET (FLORA MUG)

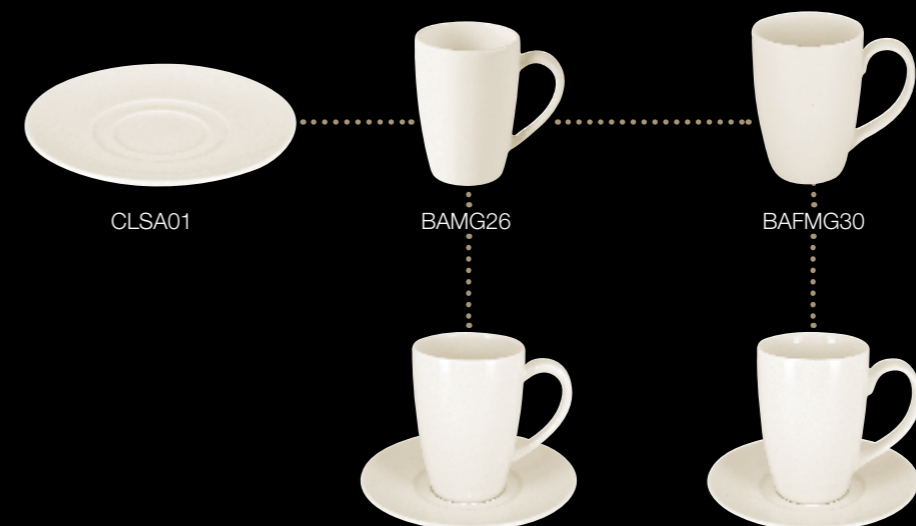

CLSA01
Universal Saucer
15 cm / 6"
ø 5.2 - 7.6 cm / 2 - 3"



CLSA02
Universal Saucer
17 cm / 6 2/3"
ø 5.2 / 2"



SPRP18IN
Allspice
18 x 14 cm / 7 x 5 1/2"
ø 5 - 7.2 cm / 2 - 2 5/6"



SPRP24IN
Allspice
24 x 14 cm / 9 4/9 x 5 1/2"
ø 5 - 6.7 - 9 cm / 2 - 2 2/3 - 3 1/2"



SPRP28IN
Allspice
28 x 14 cm / 11 x 5 1/2"
ø 5 - 7 cm / 2 - 2 3/4"



BACS01
Banquet



BACS02
Banquet



BACS18
Banquet



BACS30
Banquet



BACU18
Banquet



BACU20
Banquet



BACU23
Banquet



CLSA01
Universal Saucer
15 cm / 6"
ø 5.2 - 7.6 cm / 2 - 3"



CLSA02
Universal Saucer
17 cm / 6 2/3"
ø 5.2 / 2"



SPRP18IN
Allspice
18 x 14 cm / 7 x 5 1/2"
ø 5 - 7.2 cm / 2 - 2 5/6"



SPRP24IN
Allspice
24 x 14 cm / 9 4/9 x 5 1/2"
ø 5 - 6.7 - 9 cm / 2 - 2 2/3 - 3 1/2"



SPRP28IN
Allspice
28 x 14 cm / 11 x 5 1/2"
ø 5 - 7 cm / 2 - 2 3/4"



BAGB35
Banquet



BANC22
Banquet



CLCR25
Classic Gourmet



CLCS30
Classic Gourmet



FDCP35
Fine Dine



FDCU09
Fine Dine



FDCU20
Fine Dine



CLSA01
Universal Saucer
15 cm / 6"
ø 5.2 - 7.6 cm / 2 - 3"



CLSA02
Universal Saucer
17 cm / 6 2/3"
ø 5.2 / 2"



SPRP18IN
Allspice
18 x 14 cm / 7 x 5 1/2"
ø 5 - 7.2 cm / 2 - 2 5/6"



SPRP24IN
Allspice
24 x 14 cm / 9 4/9 x 5 1/2"
ø 5 - 6.7 - 9 cm / 2 - 2 2/3 - 3 1/2"



SPRP28IN
Allspice
28 x 14 cm / 11 x 5 1/2"
ø 5 - 7 cm / 2 - 2 3/4"



FDCU25
Fine Dine



FDCU30
Fine Dine



FDCU30M1
Fine Dine



FDMU30
Fine Dine



FDTP40
Fine Dine



GDCU09
White gold



GDCU09M
White Gold



CLSA01
Universal Saucer
15 cm / 6"
ø 5.2 - 7.6 cm / 2 - 3"



CLSA02
Universal Saucer
17 cm / 6 2/3"
ø 5.2 / 2"



SPRP18IN
Allspice
18 x 14 cm / 7 x 5 1/2"
ø 5 - 7.2 cm / 2 - 2 5/6"



SPRP24IN
Allspice
24 x 14 cm / 9 4/9 x 5 1/2"
ø 5 - 6.7 - 9 cm / 2 - 2 2/3 - 3 1/2"



SPRP28IN
Allspice
28 x 14 cm / 11 x 5 1/2"
ø 5 - 7 cm / 2 - 2 3/4"



GDCU21
White Gold



GDCU21M
White Gold



LRCU27
Lyra



LRSC27
Lyra



NNCS27
Nano



NNSU25
Nano



NOCU20
Nordic



CLSA01
Universal Saucer
15 cm / 6"
ø 5.2 - 7.6 cm / 2 - 3"



CLSA02
Universal Saucer
17 cm / 6 2/3"
ø 5.2 / 2"



SPRP18IN
Allspice
18 x 14 cm / 7 x 5 1/2"
ø 5 - 7.2 cm / 2 - 2 5/6"



SPRP24IN
Allspice
24 x 14 cm / 9 4/9 x 5 1/2"
ø 5 - 6.7 - 9 cm / 2 - 2 2/3 - 3 1/2"



SPRP28IN
Allspice
28 x 14 cm / 11 x 5 1/2"
ø 5 - 7 cm / 2 - 2 3/4"



NOMB1
Nordic



NOMG33
Nordic



OPSMG24
Minimax



SKCU23
Ska



SKSM30
Ska



SPCB11
Allspice



SPCU09
Allspice



CLSA01
Universal Saucer
15 cm / 6"
ø 5.2 - 7.6 cm / 2 - 3"



CLSA02
Universal Saucer
17 cm / 6 2/3"
ø 5.2 / 2"



SPRP18IN
Allspice
18 x 14 cm / 7 x 5 1/2"
ø 5 - 7.2 cm / 2 - 2 5/6"



SPRP24IN
Allspice
24 x 14 cm / 9 4/9 x 5 1/2"
ø 5 - 6.7 - 9 cm / 2 - 2 2/3 - 3 1/2"



SPRP28IN
Allspice
28 x 14 cm / 11 x 5 1/2"
ø 5 - 7 cm / 2 - 2 3/4"



NOMB1
Nordic



NOMG33
Nordic



OPSMG24
Minimax



SKCU23
Ska



SKSM30
Ska



SPCB11
Allspice



SPCU09
Allspice



Round with rim / Rund mit Rand / Ronde à aile / Redondo con ala



Irregular Design / Asymmetrisch / Asymétrique / Asimétrico



Round rimless / Rund ohne Rand / Ronde coupe / Redondo sin borde

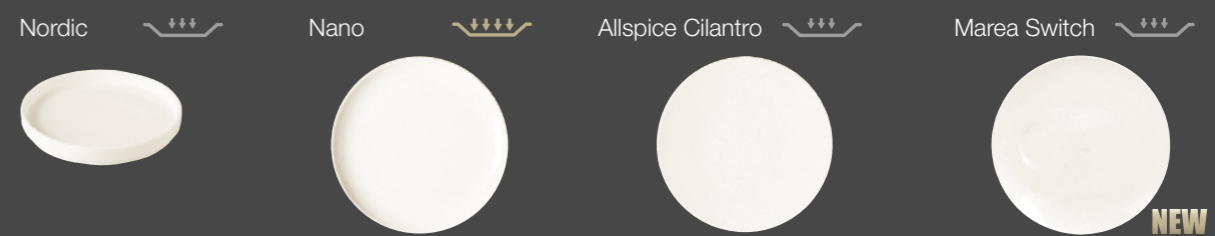

Oval / Oval / Ovale / Oval



Square / Quadratisch / Carrée / Cuadrado

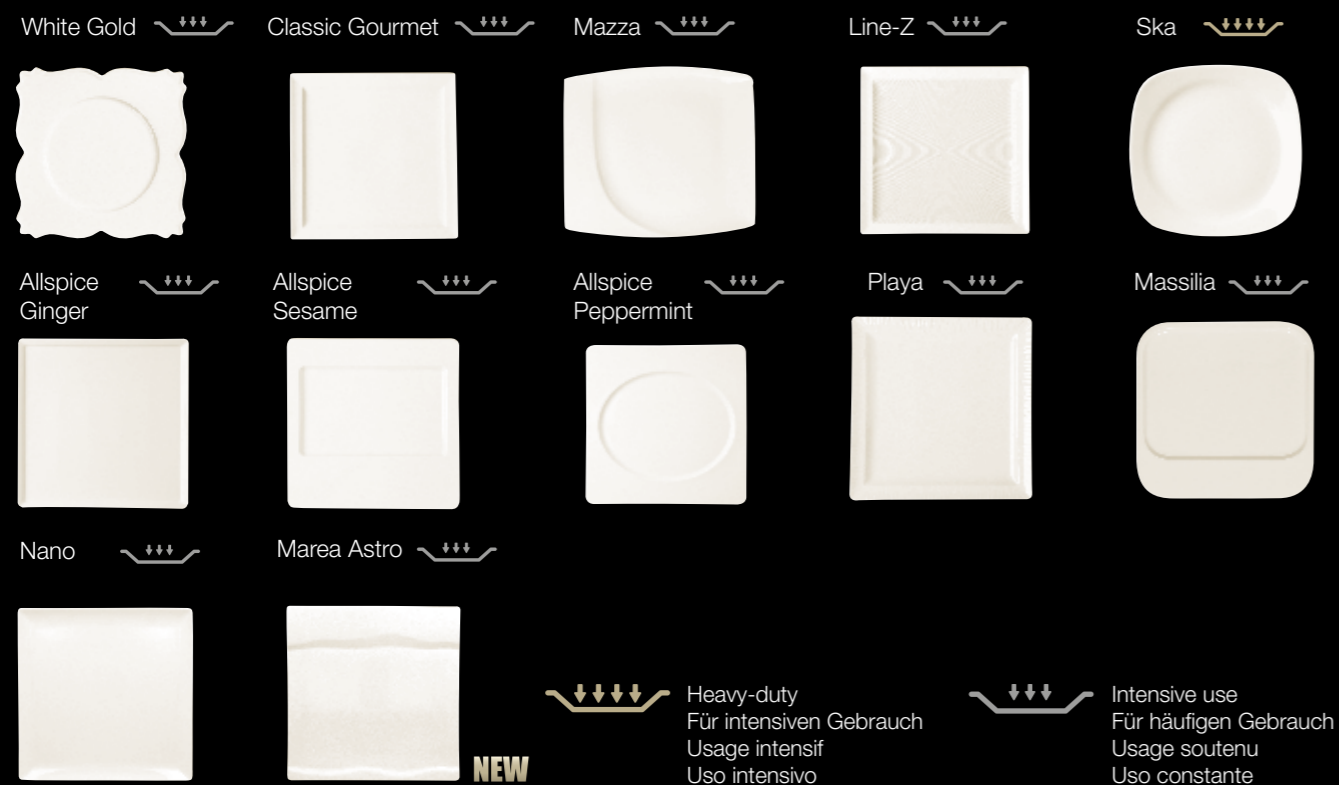

Heavy-duty
Für intensiven Gebrauch
Usage intensif
Uso intensivo



Intensive use
Für häufigen Gebrauch
Usage soutenu
Uso costante

Rectangular / Rechteckig / Rectangulaire / Rectangular



En
Cookware

Our easy-to-use "universal cooking" dishes let you cook, present and serve your culinary creations straight from oven to the table, for dining room service or a buffet presentation. Designed according to rigorous quality standards, our large dishes or individual portions simplify the daily work of catering professionals and offer a variety of products to suit every need.

Fr
Articles culinaires

Faciles d'emploi, nos plats «toutes cuissons» permettent de cuire, de présenter et de servir vos créations culinaires directement du four à la table, pour un service en salle ou pour une présentation sur buffet. Conçus à partir de critères de qualité rigoureux, nos plats de grande taille ou nos portions individuelles simplifient le travail quotidien des professionnels de la restauration et offrent une diversité adaptée à chaque besoin.

De
Kulinarische Artikel

Unsere praktischen Formen für alle Herdarten können zur Zubereitung, zum Anrichten und zum Servieren der kulinarischen Kreationen verwendet werden. So gelangen die Speisen gleich aus dem Ofen auf den Tisch oder aufs Buffet. Die nach rigorosen Qualitätskriterien entwickelten Groß- und Portions-formen erleichtern die tägliche Arbeit in der Gastronomie und bieten durch ihre große Vielfalt in jeder Situation die richtige Lösung.

Es
Artículos culinarios

De uso fácil, nuestras fuentes "para todo tipo de cocción" permiten cocinar, presentar y servir las creaciones culinarias directamente del horno a la mesa, para un servicio en sala o una presentación de tipo buffet. Concebidas con rigurosos criterios de calidad, nuestras fuentes de gran tamaño o nuestras porciones individuales simplifican el trabajo diario de los profesionales de la restauración y ofrecen una diversidad adaptada a cada necesidad.

It
Articoli per la cucina

Facili da usare, i nostri piatti "per tutte le cotture" consentono di cuocere, presentare e servire le creazioni culinarie direttamente dal forno alla tavola, sia per il servizio in sala che per la presentazione in buffet. Concepiti a partire da rigorosi criteri di qualità, i nostri piatti di grandi dimensioni e le nostre porzioni singole semplificano il lavoro quotidiano dei professionisti della ristorazione e offrono una varietà in grado di adattarsi a qualsiasi necessità.



Dishes with grip handles

Plats à oreilles
Schalen mit Griffen

Plato con asas
Piatti con manici



Oval dish with grip
Plat à oreilles ovale
Schale oval mit Griffen
Plato oval con asas
Piatto ovale con alette

OPOD30 30 x 16 x 5.2 cm - 78 cl
11 4/5 x 6 2/7 x 2" - 26 3/8 oz



Oval dish with grip
Plat à oreilles ovale
Schale oval mit Griffen
Plato oval con asas
Piatto ovale con alette

OPOD25 25 x 14 x 4.3 cm - 42 cl
9 5/6 x 5 1/2 x 1 2/3" - 14 1/5 oz



Oval dish with grip
Plat à oreilles ovale
Schale oval mit Griffen
Plato oval con asas
Piatto ovale con alette

OPOD24 24 x 13 x 4 cm - 32.5 cl
9 4/9 x 5 1/8 x 1 4/7" - 11 oz



Oval dish with grip
Plat à oreilles ovale
Schale oval mit Griffen
Plato oval con asas
Piatto ovale con alette

OPOD20 20 x 11 x 3.5 cm - 20 cl
7 7/8 x 4 1/3 x 1 3/8" - 6 3/4 oz



Round dish with grip
Plat à oreilles rond
Schale rund mit Griffen
Plato redondo con asas
Piatto rotondo con alette

OPRD16 21.5 x 18 x 4 cm - 45 cl
8 1/2 x 7 x 1 4/7" - 15 2/9 oz



Rectangular dish with grip
Plat rectangulaire à poignées
Platte rechteckig mit Griffen
Plato rectangular con asas
Piatto rettangolare con manici

OPRT16 16.3 x 9.5 x 2.7 cm - 14.5 cl
6 3/7 x 3 3/4 x 1" - 5 oz



Large dishes

Plats de grande taille
Große Schalen

Fuentes grandes
Piatti e grande



Oval dish
Plat ovale
Platte oval
Fuente oval
Vassoio ovale

BUOD30 30 x 20 x 6 cm
11 4/5 x 7 7/8 x 2 1/3"



Oval dish
Plat ovale
Platte oval
Fuente oval
Vassoio ovale

BUOD28 28 x 19 x 6 cm
11 x 7 1/2 x 2 1/3"



Oval dish
Plat ovale
Platte oval
Fuente Oval
Vassoio ovale

BUOD25 25 x 18 x 5 cm
9 5/6 x 7 x 2"



Oval platter
Plat ovale
Platte oval
Fuente oval
Vassoio ovale

BUOP56 56 x 21 x 5.5 cm - 220 cl
22 x 8 1/4 x 2 1/6"



Dishes/Ramekins

Plats creux/Ramequins Platos hondos/Cuencos
Schalen/Auflaufformen Piatti fondi/Stampi



Square dish

Ravier carré
Schale quadratisch
Rabanera cuadrada
Coppetta quadrata

SKSTD11 11 cm - 21 cl
4 1/3" - 7 oz

12



Stackable oval pie dish

Plat à gratin ovale empilable
Kuchenteller oval stapelbar
Fuenteva tarta oval apilable
Piatto per torta ovale impilabile

OPOS20 20 x 12 cm - 42 cl
7 7/8 x 4 5/7" - 14 1/5 oz

6



Pie dish

Plat à gratin
Platte für Gratin
Plato a gratin
Piatto per torta

OPPD15 15 x 11 cm - 28 cl
6 x 4 1/3" - 9 1/2 oz

6



Rectangular dish

Ravier rectangulaire
Schale rechteckig
Rabanera rectangular
Coppetta rettangolare

SKRTD15 15 x 10 cm - 22 cl
6 x 4" - 7 3/7 oz

12



Ramekin Chives

Ramequin Chives
Auflaufform Chives
Cuenco Chives
Stampo Chives

SPCB32 14 cm - 3.5 cm - 32 cl
5 1/2" - 1 3/8" - 10 4/5 oz

6



Ramekin Chives

Ramequin Chives
Auflaufform Chives
Cuenco Chives
Stampo Chives

SPCB20 11 cm - 3.5 cm - 20 cl
4 1/3" - 1 3/8" - 6 3/4 oz

6



Ramekin Chives

Ramequin Chives
Auflaufform Chives
Cuenco Chives
Stampo Chives

SPCB11 8 cm - 3.5 cm - 11 cl
3 1/7" - 1 3/8" - 3 5/7 oz

6



Stackable ramekin

Ramequin empilable
Auflaufform stapelbar
Cuenco apilable
Stampo impilabile

BABR02 8 cm - 3.5 cm - 10 cl
3 1/7" - 1 3/8" - 3 3/8 oz

12



Stackable ramekin

Ramequin empilable
Auflaufform stapelbar
Cuenco apilable
Stampo impilabile

BABR03 7 cm - 3 cm - 6 cl
2 3/4" - 1 1/6" - 2 oz

12



Ramekin

Ramequin
Auflaufform
Cuenco
Stampo

BABR01 6.7 cm - 3.5 cm - 6 cl
2 2/3" - 1 3/8" - 2 oz

12



Ramekin with grooves

Ramequin plissé
Auflaufform gerillt
Ramequin estriado
Stampo scanalato

ACRG10 10 cm - 7 cm - 33 cl
4" - 2 3/4" - 11 1/6 oz

12



Ramekin with grooves

Ramequin plissé
Auflaufform gerillt
Ramequin estriado
Stampo scanalato

ACRG09 9 cm - 5 cm - 19 cl
3 1/2" - 2" - 6 3/7"

12



Ramekin

Ramequin
Auflaufform
Cuenco
Stampo

BABW14 14 cm - 6.5 cm - 63 cl
5 5/9" - 2 1/2" - 22 1/6 oz

12



Ramekin

Ramequin
Auflaufform
Cuenco
Stampo

BABW12 12 cm - 6.5 cm - 48 cl
4 4/5" - 2 1/2" - 16 8/9 oz

12



Square bowl

Coupelle carrée
Schälchen quadratisch
Bol cuadrado
Coppetta quadrata

OPFB10 10 cm - 4 cm - 18 cl
4" - 1 4/7" - 6 oz

12

Pieces per box
Pièces par boîte
Stück pro Karton
Piezas por caja
Pezzi per scatola

Extra time for deliveries
Délai supplémentaire
Zusätzliche Lieferzeit
Periodo de abastecimiento adicional
Termine di consegna supplementare

Tureen/Casseroles

Terrines/Cassolettes
Terrines/Pfännchen

Tarrinas/Cacerola
Terrine/Piccole pirofile rotonde



Rectangular tureen & lid
Terrine rectangulaire & couvercle
Terrine rechteckig & Deckel
Tarrina rectangular & tapa
Terrina rettangolare & coperchio

OPTU23 23 x 18 cm - 14 cm - 160 cl
9 x 7" - 5 2/5" - 5 1/2" - 54 oz



Rectangular tureen & lid
Terrine rectangulaire & couvercle
Terrine rechteckig & Deckel
Tarrina rectangular & tapa
Terrina rettangolare & coperchio

OPTU20 20 x 15.5 cm - 12 cm - 104 cl
7 2/3 x 6" - 4 4/7" - 35 1/6 oz



Rectangular tureen & lid
Terrine rectangulaire & couvercle
Terrine rechteckig & Deckel
Tarrina rectangular & tapa
Terrina rettangolare & coperchio

OPTU16 16.5 x 13.5 cm - 10 cm - 60 cl
6 1/2 x 5 1/3" - 4" - 20 2/7 oz



Rectangular tureen & lid
Terrine rectangulaire & couvercle
Terrine rechteckig & Deckel
Tarrina rectangular & tapa
Terrina rettangolare & coperchio

OPTU15 15 x 12 cm - 9 cm - 39 cl
6 x 4 2/3" - 3 1/2" - 13 1/5 oz



Rectangular tureen & lid
Terrine rectangulaire & couvercle
Terrine rechteckig & Deckel
Tarrina rectangular & tapa
Terrina rettangolare & coperchio

OPTU13 13 x 10 cm - 8 cm - 30 cl
5 1/8 x 4" - 3" - 10 1/7 oz



Rectangular tureen & lid
Terrine rectangulaire & couvercle
Terrine rechteckig & Deckel
Tarrina rectangular & tapa
Terrina rettangolare & coperchio

OPTU12 12 x 9 cm - 7 cm - 20 cl
4 3/5 x 3 5/8" - 2 3/4" - 6 3/4 oz



Handi* bowl & lid
Bol Handi & couvercle
Handi Schale & Deckel
Bol Handi & tapa
Coppetta bombata Handi

OPHB85 18.5 cm - 13 cm - 150 cl
7 2/7" - 5 1/8" - 50 5/7 oz



Handi* bowl & lid
Bol Handi & couvercle
Handi Schale & Deckel
Bol Handi & tapa
Coppetta bombata Handi

OPHB89 19.5 cm - 10 cm - 90 cl
7 2/3" - 4" - 30 3/7 oz



Handi* bowl & lid
Bol Handi & couvercle
Handi Schale & Deckel
Bol Handi & tapa
Coppetta bombata Handi

OPHB85 16.5 cm - 11 cm - 85 cl
6 1/2" - 4 1/3" - 28 3/4 oz



Handi* bowl & lid
Bol Handi & couvercle
Handi Schale & Deckel
Bol Handi & tapa
Coppetta bombata Handi

OPHB50 15.5 cm - 9 cm - 50 cl
6 1/9" - 3 1/2" - 17 oz



**Handi is an indish bowl*

**Handi est un bol indien*

**Handi ist eine indische Schale*

**Handi es un bol indio*

**Handi è una ciotola indiana*

Pieces per box
Pièces par boîte
Stück pro Karton
Piezas por caja
Pezzi per scatola

Extra time for deliveries
Délai supplémentaire
Zusätzliche Lieferzeit
Periodo de abastecimiento adicional
Termine di consegna supplementare

PLATES SPECIFICATIONS

Reference Référence Referenz Referencia Riferimento	Item Article Artikel Artículo Articolo	Profile view Vue de profil Profilschnitt Vista de perfil Vista laterale	Thickness of the rim Épaisseur de l'aile Randstärke Espesor de la ala Spessore del bordo	Profile type Type de profil Profiltyp Tipo de perfil Tipo di profilo	Lateral shock resistance Résistance aux chocs latéraux Bruchwiderstand Resistencia de choque lateral Resistenza agli urti laterali	Weight Poids Gewicht Peso Peso	Recommendations of use Recommandations d'usage Gebrauchsempfehlungen Recomendación de uso Consigli per l'uso	Design perception Perception design Design-Empfindung Percepción diseño Percezione del design		
MRDP27 NEW	Marea Switch 27 cm - 10 5/8"		4.0 mm 1/6"	Sharp Saillant Scharf Saliente Sporgente	★★	640 g 1 2/5 lb	Intensive Soutenu Sehr häufig Constante Costante	Fine dining Restauration haut de gamme Top-Gastronomie Restauración de gama alta Ristorazione di alta gamma	Premium Premium Premium Premium Premium	★★★★★
GIFP27 NEW	Giro round plate 27 cm - 10 5/8"		3.9 mm 1/6"	Sharp Saillant Scharf Saliente Sporgente	★★	622 g 1 3/8 lb	Intensive Soutenu Sehr häufig Constante Costante	Fine dining Restauration haut de gamme Top-Gastronomie Restauración de gama alta Ristorazione di alta gamma	Premium Premium Premium Premium Premium	★★★★★
FDFP27	Fine Dine 27 cm - 10 5/8"		3.6 mm 1/7"	Sharp Saillant Scharf Saliente Sporgente	★★	640 g 1 2/5 lb	Intensive Soutenu Sehr häufig Constante Costante	Fine dining Restauration haut de gamme Top-Gastronomie Restauración de gama alta Ristorazione di alta gamma	Premium Premium Premium Premium Premium	★★★★★
NOFP28	Nordic 28 cm - 11"		3.0 mm 1/8"	Sharp Saillant Scharf Saliente Sporgente	★★	810 g 1 4/5 lb	Intensive Soutenu Sehr häufig Constante Costante	Fine dining Restauration haut de gamme Top-Gastronomie Restauración de gama alta Ristorazione di alta gamma	Premium Premium Premium Premium Premium	★★★★★
GDSP26	White Gold King* 26 cm - 10 1/4"		5.0 mm 1/5"	Rolled Rond Rund Redondo Rotondo	★★★★	970 g 2 1/8 lb	Intensive Soutenu Sehr häufig Constante Costante	Fine dining Restauration haut de gamme Top-Gastronomie Restauración de gama alta Ristorazione di alta gamma	Premium Premium Premium Premium Premium	★★★★★
LRFP27	Lyra 27 cm - 10 5/8"		4.8 mm 1/5"	Sharp Saillant Scharf Saliente Sporgente	★★	710 g 1 5/9 lb	Intensive Soutenu Sehr häufig Constante Costante	Fine dining Restauration haut de gamme Top-Gastronomie Restauración de gama alta Ristorazione di alta gamma	Premium Premium Premium Premium Premium	★★★★★
NBFP27	Nabur 27 cm - 10 5/8"		4.0 mm 1/6"	Rolled Rond Rund Redondo Rotondo	★★	676 g 1 1/4 lb	Intensive Soutenu Sehr häufig Constante Costante	Fine dining Restauration haut de gamme Top-Gastronomie Restauración de gama alta Ristorazione di alta gamma	Premium Premium Premium Premium Premium	★★★★
ANFP27	Anna 27 cm - 10 5/8"		5 mm 1/5"	Strength Rond renforcé Rund verstärkt Redondeado reforzado Rotondo rinforzato	★★★★★	810 g 1 7/9 lb	Heavy-duty Intensif Intensiv Intensivo Intensivo	Bistro-Brasserie - banqueting - catering Bistro-Brasserie - banqueting - catering Großgaststätten - banqueting - catering Bar - cervecería - banquets - catering Bistro, brasserie, banchetti, catering	Elegant Élegant Elegant Elegante	★★★★
MSFP27	Massilia 27 cm - 10 5/8"		4.0 mm 1/6"	Sharp Saillant Scharf Saliente Sporgente	★★★★	730 g 1 5/8 lb	Intensive Soutenu Sehr häufig Constante Costante	Fine dining Restauration haut de gamme Top-Gastronomie Restauración de gama alta Ristorazione di alta gamma	Premium Premium Premium Premium Premium	★★★★

* Also applies on Golden and Pure / Auch auf Golden und Pure anwendbar / Applicable également sur Golden et Pure / Aplicable también sobre Golden y Pure / Applicabile anche alla collezione Golden e Pure

PLATES SPECIFICATIONS

Reference Référence Referenz Referencia Riferimento	Item Article Artikel Artículo Articolo	Profile view Vue de profil Profilschnitt Vista de perfil Vista laterale	Thickness of the rim Épaisseur de l'aile Randstärke Espesor de la ala Spessore del bordo	Profile type Type de profil Profiltyp Tipo de perfil Tipo di profilo	Lateral shock resistance Résistance aux chocs latéraux Bruchwiderstand Resistencia de choque lateral Resistenza agli urti laterali	Weight Poids Gewicht Peso Peso	Recommendations of use Recommandations d'usage Gebrauchsempfehlungen Recomendación de uso Consigli per l'uso	Design perception Perception design Design-Empfindung Percepción diseño Percezione del design		
SPSP27	Allspice 27 cm - 10 5/8"		4.0 mm 1/6"	Sharp Saillant Scharf Saliente Sporgente	★★	900 g 2 lb	Intensive Soutenu Sehr häufig Constante Costante	Fast moving restaurants Restauration traditionnelle Großgastronomie Restauración tradicional Ristorazione tradizionale	Elegant Élegant Elegant Elegante Elegante	★★★
MZSP26	Mazza 26 cm - 10 1/4"		4.5 mm 1/6"	Sharp Saillant Scharf Saliente Sporgente	★★	640 g 1 2/5 lb	Semi-intensive Semi-intensif Häufig Semi-intensivo Semi-intensivo	Fast moving restaurants Restauration traditionnelle Großgastronomie Restauración tradicional Ristorazione tradizionale	Elegant Élegant Elegant Elegante Elegante	★★★
CLFP27	Classic Gourmet* 27 cm - 10 5/8"		5.0 mm 1/5"	Strength Rond renforcé Rund verstärkt Redondeado reforzado Rotondo rinforzato	★★★★★	700 g 1 1/2 lb	Heavy-duty Intensif Intensiv Intensivo Intensivo	Bistro-Brasserie - banqueting - catering Bistro-Brasserie - banqueting - catering Großgaststätten - banqueting - catering Bar - cervecería - banquets - catering Bistro, brasserie, banchetti, catering	Elegant Élegant Elegant Elegante Elegante	★★★
SKRFP28	Ska Round 28 cm - 11"		4.5 mm 1/6"	Rolled Rond Rund Redondo Rotondo	★★★	930 g 2 lb	Heavy-duty Intensif Intensiv Intensivo Intensivo	Bistro-Brasserie - banqueting - catering Bistro-Brasserie - banqueting - catering Großgaststätten - banqueting - catering Bar - cervecería - banquets - catering Bistro, brasserie, banchetti, catering	Standard Courant Standard Estándar Ordinario	★★
PXFP27	Pixel 27 cm - 10 5/8"		5.0 mm 1/5"	Strength Rond renforcé Rund verstärkt Redondeado reforzado Rotondo rinforzato	★★★★★	730 g 1 5/8 lb	Heavy-duty Intensif Intensiv Intensivo Intensivo	Bistro-Brasserie - banqueting - catering Bistro-Brasserie - banqueting - catering Großgaststätten - banqueting - catering Bar - cervecería - banquets - catering Bistro, brasserie, banchetti, catering	Standard Courant Standard Estándar Ordinario	★★
SKSFP27	Ska Square 27 cm - 10 5/8"		5.1 mm 1/5"	Rolled Rond Rund Redondo Rotondo	★★★★★	915 g 2 lb	Heavy-duty Intensif Intensiv Intensivo Intensivo	Bistro-Brasserie - banqueting - catering Bistro-Brasserie - banqueting - catering Großgaststätten - banqueting - catering Bar - cervecería - banquets - catering Bistro, brasserie, banchetti, catering	Strong, standard Robuste, courant Robust, standard Robusto, estándar Robusto, ordinario	★★
BAFP27	Banquet** 27 cm - 10 5/8"		5.1 mm 1/5"	Strength Rond renforcé Rund verstärkt Redondeado reforzado Rotondo rinforzato	★★★★★	755 g 1 2/3 lb	Heavy-duty Intensif Intensiv Intensivo Intensivo	Bistro-brasserie - banqueting - catering Bistro-brasserie - banqueting - catering Großgaststätten - banqueting - catering Bar - cervecería - banquets - catering Bistro, brasserie, banchetti, catering	Strong, standard Robuste, courant Robust, standard Robusto, estándar Robusto, ordinario	★★
NNPR27	Nano** 27 cm - 10 5/8"		4 mm 1/6"	Rolled Rond Rund Redondo Rotondo	★★	730 g 1 5/8 lb	Semi-intensive Semi-intensif Häufig Semi-intensivo Semi-intensivo	Bistro-brasserie - banqueting - catering Bistro-brasserie - banqueting - catering Großgaststätten - banqueting - catering Bar - cervecería - banquets - catering Bistro, brasserie, banchetti, catering	Standard Courant Standard Estándar Ordinario	★★

* Also applies on Line-Z and Playa / Applicable également sur Line-Z et Playa / Auch auf Line-Z und Playa anwendbar / Aplicable también sobre Line Z y Playa / Applicabile anche alla collezione Line-Z e Playa

** Also applies on Metropolis, Leon, Rondo and decorated items Bahamas 2 / Applicable également sur Metropolis, Leon, Rondo et les éléments décoratifs Bahamas 2 / Auch auf Metropolis, Leon, Rondo anwendbar und Dekorationselemente Bahamas 2 / Aplicable también sobre Metropolis Leon, Rondo y artículos decorados Bahamas 2 / Applicabile anche alle collezioni Metropolis, Leon e Rondo, nonché agli elementi decorativi della linea Bahamas 2

*** Also applies on Skola / Applicable sur Skola / Auch auf Skola / Aplicable también sobre Skola / Applicabile anche Skola



MAKE SURE
IT'S RAK

Printed by: Imprimerie Centrale S.A. (Luxembourg)
Concept and graphic design by: Dechmann Communication sàrl (Luxembourg)
Photo credits: Matthieu Cellard, Cyrille Boulanger, Lukas Bidinger, John Oesch, Frank Weber
Cover's picture by: Lukas Bidinger / Fotoplus Luzern